



DVD Player

DVD-HD755



Important Safety Instructions

- 1) Read these instructions.
- 2) Keep these instructions.
- 3) Heed all warnings.
- 4) Follow all instructions.
- 5) Do not use this apparatus near water.
- 6) Clean only with dry cloth.
- 7) Do not block any ventilation openings, install in accordance with the manufacturer's instructions.
- 8) Do not install near any heat sources such as radiators, heat registers, or other apparatus (including amplifiers) that produce heat.
- 9) Do not defeat the safety purpose of the polarized or grounding- type plug. A polarized plug has two blades with one wider than the other. A grounding type plug has two blades and a third grounding prong. The wide blade or the third prong are provided for your safety. If the provided plug does not fit into your outlet, consult an electrician for replacement of the obsolete outlet.
- 10) Protect the power cord from being walked on or pinched particularly at plugs, convenience receptacles, and the point where they exit from the apparatus.
- 11) Only use attachments/accessories specified by the manufacturer.
- 12) Use only with cart, stand, tripod, bracket, or table specified by the manufacturer, or sold with the apparatus.
- 13) Unplug this apparatus. When a cart is used, use caution when moving the cart/apparatus combination to avoid injury from tip-over.
- 14) Refer all servicing to qualified service personnel. Servicing is required when the apparatus has been damaged in any way, such as power-supply cord or plug is damaged, liquid has been spilled or objects have fallen into the apparatus the apparatus has been exposed to rain or moisture, does not operate normally, or has been dropped.



Precautions

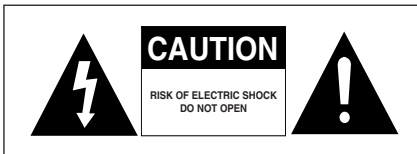

TO REDUCE THE RISK OF ELECTRIC SHOCK, DO NOT REMOVE THE COVER(OR BACK). NO USER-SERVICEABLE PARTS ARE INSIDE. REFER SERVICING TO QUALIFIED SERVICE PERSONNEL.



This symbol indicates “dangerous voltage” inside the product that presents a risk of electric shock or personal injury.



This symbol indicates important instructions accompanying the product.

Do not install this equipment in a confined space such as a bookcase or similar unit.

WARNING : To prevent damage which may result in fire or electric shock hazard, do not expose this appliance to rain or moisture.

CAUTION : DVD PLAYERS USE AN INVISIBLE LASER BEAM WHICH CAN CAUSE HAZARDOUS RADIATION EXPOSURE IF DIRECTED.
BE SURE TO OPERATE PLAYER CORRECTLY AS INSTRUCTED.

CAUTIONS

Caution: To prevent electric shock, match wide blade of plug to wide slot, fully insert.

Attention: Pour éviter les chocs électriques, introduire la lame la plus large de la fiche dans la borne correspondante de la prise et pousser jusqu'au fond.

This product satisfies FCC regulations when shielded cables and connectors are used to connect the unit to other equipment. To prevent electromagnetic interference with electric appliances, such as radios and televisions, use shielded cables and connectors for connections.

FCC NOTE (for U.S.A):

This equipment has been tested and found to comply with the limits for a Class B digital device, pursuant to Part 15 of the FCC rules. These limits are designed to provide reasonable protection against harmful interference in a residential installation. This equipment generates, uses and can radiate radio frequency energy and, if not installed and used in accordance with the instructions, may cause harmful interference to radio or television reception, which can be determined by turning the equipment off and on.

The user is encouraged to try to correct the interference by one or more of the following measures.

- Reorient or relocate the receiving antenna.
- Increase the separation between the equipment and receiver.
- Connect this equipment into an outlet on a circuit different from that to which the receiver is connected.
- Consult the dealer or an experienced radio/TV technician for help.

This class B digital apparatus meets all requirements of the Canadian Interference -- Causing Equipment Regulations.

CLASS 1 LASER PRODUCT
KLASSE 1 LASER PRODUKT
LUOKAN 1 LASER LAITE
KLASS 1 LASER APPARAT
PRODUCTO LÁSER CLASE 1

CAUTION

THIS PRODUCT UTILIZES A LASER. USE OF CONTROLS OR ADJUSTMENTS OR PERFORMANCE OF PROCEDURES OTHER THAN THOSE SPECIFIED HEREIN MAY RESULT IN HAZARDOUS RADIATION EXPOSURE. DO NOT OPEN COVER AND DO NOT REPAIR YOURSELF. REFER SERVICING TO QUALIFIED PERSONNEL.

Note:

- This unit can be used only where the power supply is AC 120V, 60Hz. It cannot be used elsewhere.
- This DVD player is designed and manufactured to respond to the Region Management Information. If the Region number of a DVD disc does not correspond to the Region number of this DVD player, the DVD player cannot play the disc.
- The product unit accompanying this user manual is licensed under certain intellectual property rights of certain third parties. In particular, this product is licensed under the following US patents: 5,991,715, 5,740,317, 4,972,484, 5,214,678, 5,323,396, 5,539,829, 5,606,618, 5,530,655, 5,777,992, 6,289,308, 5,610,985, 5,481,643, 5,544,247, 5,960,037, 6,023,490, 5,878,080, and under US Published Patent Application No. 2001-44713-A1.

This license is limited to private non-commercial use by end-user consumers for licensed contents. No rights are granted for commercial use. The license does not cover any product unit other than this product unit and the license does not extend to any unlicensed product unit or process conforming to ISO/IEC 11172-3 or ISO/IEC 13818-3 used or sold in combination with this product unit.

The license only covers the use of this product unit to encode and/or decode audio files conforming to the ISO/IEC 11172-3 or ISO/IEC 13818-3. No rights are granted under this license for product features or functions that do not conform to the ISO/IEC 11172-3 or ISO/IEC 13818-3.

Handling Cautions

- Before connecting other components to this player, be sure to turn them all off.
- Do not move the player while a disc is being played, or the disc may be scratched or broken, and the player's internal parts may be damaged.
- Do not put a flower vase filled with water or any small metal objects on the player.
- Be careful not to put your hand into the disc tray.
- Do not place anything other than the disc in the disc tray.
- Exterior interference such as lightning and static electricity can affect normal operation of this player. If this occurs, turn the player off and on again with the **POWER** button, or disconnect and then reconnect the AC power cord to the AC power outlet. The player will operate normally.
- Be sure to remove the disc and turn off the player after use.
- Disconnect the AC power cord from the AC outlet when you don't intend to use the player for long periods of time.
- Clean the disc by wiping in a straight line from the inside to the outside of the disc.

Disc Storage

Be careful not to harm the disc because the data on these discs is highly vulnerable to the environment.

- Do not keep under direct sunlight.
- Keep in a cool ventilated area.
- Store vertically.
- Keep in a clean protection jacket.

Maintenance of Cabinet

For safety reasons, be sure to disconnect the AC power cord from the AC outlet.

- Do not use benzene, thinner, or other solvents for cleaning.
- Wipe the cabinet with a soft cloth.

Before you start

Accessories



Remote Control
(AK59-00011K)



Batteries for Remote Control
(AAA Size)
(AC43-12002H)

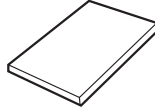

User's Manual
(AK68-00846A)

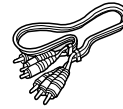

Video/Audio Cable
(AC39-42001R)



HDMI Cable
(MF39-00299A)

Install Batteries in the Remote control

1

Open the battery cover on the back of the remote control.

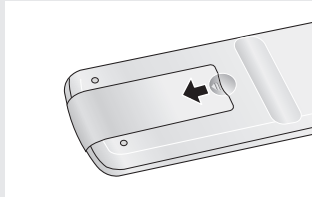

2

Insert two AAA batteries. Make sure that the polarities (+ and -) are aligned correctly.

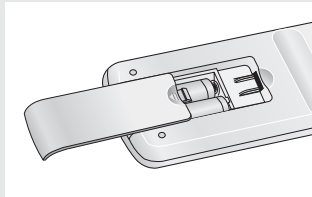

3

Replace the battery cover.

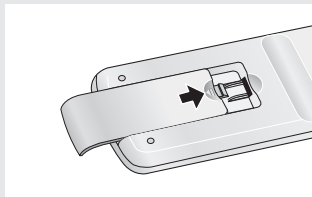

If the remote control doesn't operate properly:

- Check the polarity + - of the batteries (Dry-Cell)
- Check if the batteries are drained.
- Check if remote control sensor is blocked by obstacles.
- Check if there is any fluorescent lighting nearby.

TABLE OF CONTENTS

Important Safety Instructions	2
Precautions	3
Before you start	5
Chapter 1: Setup	
General Features	7
Disc Type and Characteristics	8
Description	9
Tour of the Remote Control	11
Chapter 2: Connections	
Choosing a Connection	12
Chapter 3: Basic Functions	
Playing a Disc	20
Using the Search and Skip Functions	22
Using the Display Function	23
Using the Disc and Title Menu	25
Using the Function Menu	26
Repeat Play	27
Slow Repeat Play	28
Program Play & Random Play	29
Chapter 4: Advanced Functions	
Adjusting the Aspect Ratio (EZ View)	30
Selecting the Audio Language	32
Selecting the Subtitle Language	33
Changing the Camera Angle	34
Using the Instant Replay/Skip Function	34
Using the Bookmark Function	35
Using the Zoom Function	37
Clips Menu for MP3/WMA/JPEG	38
Folder Selection	38
MP3/WMA Playback	39
Picture CD Playback	41
Chapter 5: Changing Setup Menu	
Using the Setup Menu	43
Setting Up EZ-Setup	44
Setting Up the Language Features	46
Setting Up the Audio Options	50
Setting Up the Display Options	52
Setting Up the Parental Control	55
Chapter 6: Reference	
Troubleshooting	58
Specifications	60

Chapter 1

SETUP

General Features

Excellent Sound

Dolby Digital, a technology developed by Dolby Laboratories, provides crystal clear sound reproduction.

Screen

Both regular and widescreen(16:9) pictures can be viewed.

Slow Motion

An important scene can be viewed in slow motion.

Program Play (CD)

You can program tracks to play in desired order.

Parental Control (DVD)

The parental control allows users to set the level necessary to prohibit children from viewing harmful movies such as those with violence, adult subject matter, etc.

Various On-Screen Menu Functions

You can select various languages (Audio/Subtitle) and screen angles while enjoying movies.

Progressive Scan

Progressive scanning creates an improved picture with double the scan lines of a conventional interlaced picture.

EZ VIEW (DVD)

Easy View enables picture adjustment to match your TV's screen size (16:9 or 4:3).

Digital Photo Viewer (JPEG)

You can view Digital Photos on your TV.

Repeat

You can repeat a song or movie simply by pressing the **REPEAT** button.

MP3/WMA

This unit can play discs created from MP3/WMA files.

Instant Replay (DVD)

This function is used to replay the previous 10 seconds of a movie from the current position.

Instant Skip (DVD)

This function skips playback ahead 10 seconds.

HDMI (High Definition Multimedia Interface)

HDMI reduces picture noise by allowing a pure digital video/audio signal path from the player to your TV.

Note

- Discs which cannot be played with this player.
 - DVD-ROM
 - DVD-RAM
 - CD-ROM
 - CDV
 - CDI
 - CVD
 - Super Audio CD(except CD layer)
 - CDGs play audio only, not graphics.
- Ability to play back the following discs may depend on recording conditions.
 - DVD-R, +R
 - CD-RW
 - DVD+RW, -RW (V mode)
- The unit may not play certain CD-R, CD-RW and DVD-R discs due to the disc type or recording conditions.

COPY PROTECTION

Many DVD discs are encoded with copy protection. Because of this, you should only connect your DVD player directly to your TV, not to a VCR. Connecting to a VCR results in a distorted picture from copy-protected DVD discs.

This product incorporates copyright protection technology that is protected by methods claims of certain U.S. patents and other intellectual property rights owned by Macrovision Corporation and other rights owners. Use of this copyright protection technology must be authorized by Macrovision Corporation, and is intended for home and other limited viewing uses only unless otherwise authorized by Macrovision Corporation. Reverse engineering or disassembly is prohibited.



PROGRESSIVE SCAN OUTPUTS (525p)

PLEASE NOTE THAT NOT ALL HIGH DEFINITION TELEVISION SETS ARE FULLY COMPATIBLE WITH THIS PRODUCT AND MAY CAUSE ARTIFACTS TO BE DISPLAYED IN THE PICTURE. IF 525 PROGRESSIVE SCAN PICTURE PROBLEMS OCCUR, IT IS RECOMMENDED THAT THE USER SWITCH THE CONNECTION TO THE 'STANDARD DEFINITION' OUTPUT. IF THERE ARE QUESTIONS REGARDING YOUR TV SET COMPATIBILITY WITH THIS DVD PLAYER, PLEASE CONTACT SAMSUNG'S CUSTOMER SERVICE CENTER.







SETUP

Disc Type and Characteristics

This DVD player is capable of playing the following types of discs with the corresponding logos:

Disc Types (Logos)	Recording Types	Disc Size	Max. Playing Time	Characteristics
DVD-VIDEO 	Audio + Video	5"	Single-sided 240 min. Double-sided 480 min.	<ul style="list-style-type: none"> - DVD contains excellent sound and video due to Dolby Digital and MPEG-2 system. - Various screen and audio functions can be easily selected through the on-screen menu.
		3 1/2"	Single-sided 80 min. Double-sided 160 min.	
VIDEO-CD 	Audio + Video	5"	74 min.	<ul style="list-style-type: none"> - Video with CD sound, VHS quality & MPEG-1 compression technology.
		3 1/2"	20 min.	
AUDIO-CD 	Audio	5"	74 min.	<ul style="list-style-type: none"> - CD is recorded as a Digital Signal with better audio quality, less distortion and less deterioration of audio quality over time.
		3 1/2"	20 min.	

Disc Markings

	Play Region Number
	NTSC broadcast system in U.S.A, Canada, Korea, Japan, etc.
	Dolby Digital disc
	Stereo disc
	Digital Audio disc
	DTS disc
	MP3 disc

Region Number

Both the DVD player and the discs are coded by region. These regional codes must match in order for the disc to play. If the codes do not match, the disc will not play.

The Region Number for this player is described on the rear panel of the player.

You must only insert one DVD disc at a time. Inserting two or more discs will not allow playback and may cause damage to the DVD player.

Description

Front Panel Controls

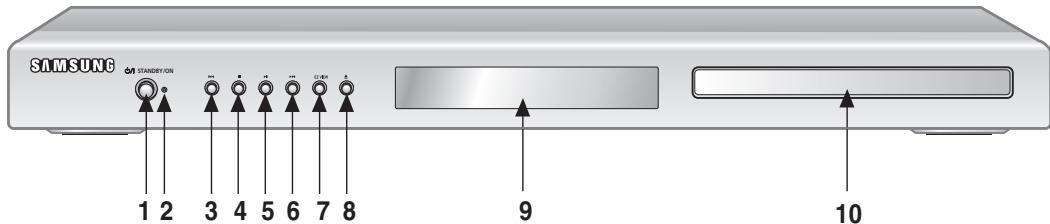

- | | |
|--|--|
| <p>1. STANDBY/ON (⏻)
When the unit is first plugged in, this indicator lights. When STANDBY/ON is pressed on, the indicator goes out and the player is turned on.</p> <p>2. POWER INDICATOR</p> <p>3. SKIP (⏮) / SEARCH
Use to reverse skip a scene or music.</p> <p>4. STOP (■)
Stops disc play.</p> <p>5. PLAY/PAUSE (▶)
Begin or pause disc play.</p> | <p>6. SKIP (⏭) / SEARCH
Use to forward skip a scene or music.</p> <p>7. EZ VIEW
The aspect ratio of a picture can easily be adjusted to your TV's screen size (16:9 or 4:3).</p> <p>8. OPEN/CLOSE (▲)
Press to open and close the disc tray.</p> <p>9. DISPLAY
Operation indicators are displayed here.</p> <p>10. DISC TRAY
Place the disc here.</p> |
|--|--|

Front Panel Display

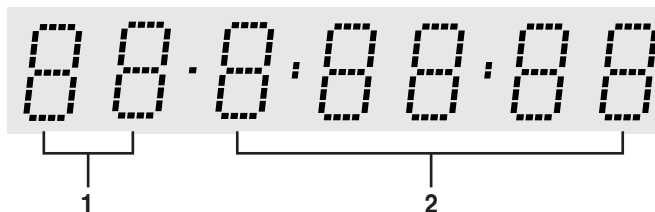

- Chapter/Track number indicator**
- Total playing time/Displays various messages concerning operations such as PLAY, STOP, LOAD ...**
no DISC: No disc loaded.
OPEN: The disc tray is open.
LOAD: Player is loading disc information.

SETUP

Rear Panel

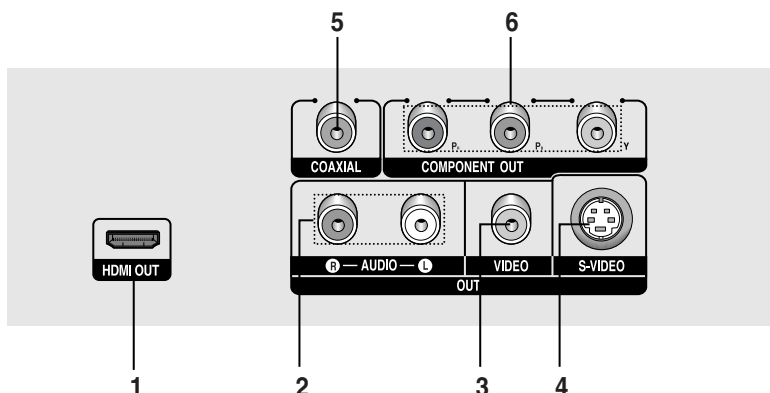

1. HDMI OUT JACK

- Use the HDMI cable to connect this jack to the HDMI jack on your television for the best quality picture.
- If an HDMI cable is connected to an HDMI-compatible TV, HDMI will be output automatically a maximum of 10 seconds later.
- If you want to use a Video, S-Video or Component Output, set the output in the menu (see page 53) or unplug the HDMI cable.

2. AUDIO OUT JACKS

Connect to the Audio input jacks of your television or audio/video receiver

3. VIDEO OUT JACK

- Use a video cable to connect to the Video input jack on your television.
- The Video Output in Setup Menu must be set to COMPOSITE/S-VIDEO.

4. S-VIDEO OUT JACK

- Use the S-Video cable to connect this jack to the S-Video jack on your television for higher picture quality.
- The Video Output in Setup Menu must be set to COMPOSITE/S-VIDEO.

5. DIGITAL AUDIO OUT JACKS

- Use a coaxial digital cable to connect to a compatible Dolby Digital receiver.
- Use a coaxial digital cable to connect to an A/V Amplifier that contains a Dolby Digital, MPEG2 or DTS decoder.

6. COMPONENT VIDEO OUT JACKS

- Use these jacks if you have a TV with Component Video in jacks. These jacks provide P_R, P_B and Y video.
- If HDMI/COMPONENT (P-SCAN) Video Output is selected in Setup Menu, progressive scan mode will work.
- If Component (I-SCAN) Video Output is selected in Setup Menu, interlaced scan mode will work.

Note

- Consult your TV User's Manual to find out if your TV supports Progressive Scan (P-SCAN). If Progressive Scan is supported, follow the TV User's Manual regarding Progressive Scan settings in the TV's menu system.
- If HDMI/COMPONENT (P-SCAN) Video Output is selected in Setup Menu, Video and S-Video Outputs do not work.
- The HDMI output of this unit can be connected to a DVI jack on a TV or other device using a conversion adapter. In this case, it is necessary to use a TV or display with an HDCP-compatible DVI input.
- There may be no image output if the DVD player is connected to a TV or display that is not compatible with the above format.
- Refer to the TV's instruction manual for detailed information regarding the HDMI terminal.
- See pages 52 ~ 54 to get more information on how to use the setup menu.

Tour of the Remote Control

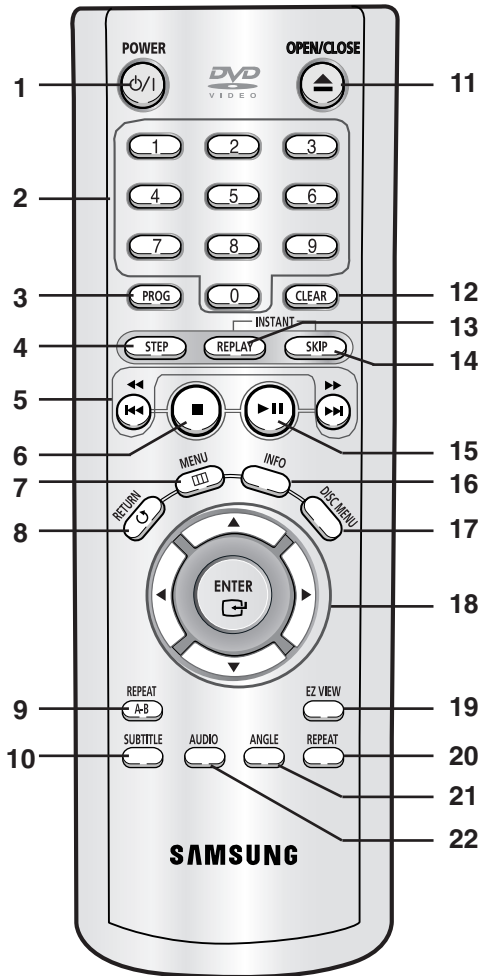

1. **DVD POWER Button**
Turns the power on or off.
2. **NUMBER Buttons**
3. **PROG Button**
Allows you to program tracks in a specific order.
4. **STEP Button**
Advances play one frame at a time.
5. **SEARCH/SKIP Buttons (◀▶, ⏮▶▶)**
Allow you to search forward/backward through a disc.
Use to skip the title, chapter or track.
6. **STOP Button (■)**
7. **MENU Button**
Brings up the DVD player's menu.
8. **RETURN Button**
Returns to a previous menu.
9. **REPEAT A-B Button**
Allows you to repeat play A-B on a disc.
10. **SUBTITLE Button**
11. **OPEN/CLOSE (▲) Button**
To open and close the disc tray.
12. **CLEAR Button**
Use to remove menus or status displays from the screen.
13. **INSTANT REPLAY Button**
This function is used to replay the previous 10 seconds of a movie from the current position.
14. **INSTANT SKIP Button**
This function skips playback ahead 10 seconds.
15. **PLAY/PAUSE Button (▶||)**
Begin/Pause disc play.
16. **INFO Button**
Displays the current disc mode.
17. **DISC MENU Button**
Brings up the Disc menu.
18. **ENTER/▲▼◀▶ Buttons**
These buttons enable you to navigate and choose items in the menu.
19. **EZ VIEW Button**
The aspect ratio of a picture can easily be adjusted according to the screen size of your TV (16:9 or 4:3).
20. **REPEAT Button**
Allows you to repeat play a title, chapter, track, or disc.
21. **ANGLE Button**
Use to access various camera angles on a DVD.
22. **AUDIO Button**
Use this button to access various audio functions on a disc.

Chapter 2

CONNECTION

Choosing a Connection

The following shows examples of connections commonly used to connect the DVD player with a TV and other components.

Before Connecting the DVD Player

- Always turn off the DVD player, TV, and other components before you connect or disconnect any cables.
- Refer to the user's manual of the additional components (such as a TV) you are connecting for more information on those particular components.

Connection to a TV (Video)

1

Using video/audio cables, connect the **VIDEO (yellow)/AUDIO (red and white) OUT** terminals on the rear of the DVD player to the **VIDEO (yellow)/AUDIO (red and white) IN** terminals of your TV.

2

Turn on the DVD player and TV.

3

Press the input selector on your TV remote control until the Video signal from the DVD player appears on the TV screen.

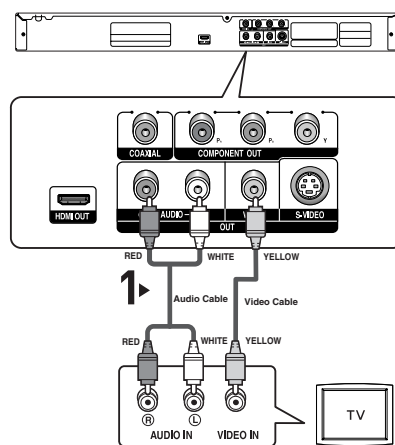

Note

- **Noise may be generated if the audio cable is placed too close to the power cable.**
- If you want to connect to an Amplifier, please refer to the Amplifier connection page. (See pages 18 to 19)
- The number and position of terminals may vary depending on your TV set. Please refer to the user's manual of your TV.
- If there is one audio input terminal on the TV, connect it to the [AUDIO OUT][left] (white) terminal of the DVD player.
- When the Video Output in Setup menu is set to HDMI/COMPONENT(P-SCAN), the Video and S-Video Outputs do not work.

CONNECTION

Connection to a TV (S-Video)

- Connecting to your TV using an S-Video cable.
- You will enjoy high quality video. S-Video separates the picture element into black and white(Y) and color(C) signals to present clearer images than regular video input mode. (Audio signals are delivered through the audio output.)

1

Using an S-Video cable (not included), connect the **S-VIDEO OUT** terminal on the rear of the DVD player to the **S-VIDEO IN** terminal of your TV.

2

Using the audio cables, connect the **AUDIO (red and white) OUT** terminals on the rear of the DVD player to the **AUDIO (red and white) IN** terminals of your TV. Turn on the DVD player and TV.

3

Press the input selector on your TV remote control until the S-Video signal from the DVD player appears on your TV screen.

4

Set the Video Output to **COMPOSITE/S-VIDEO** in the Display Setup menu. (See pages 52 to 53)

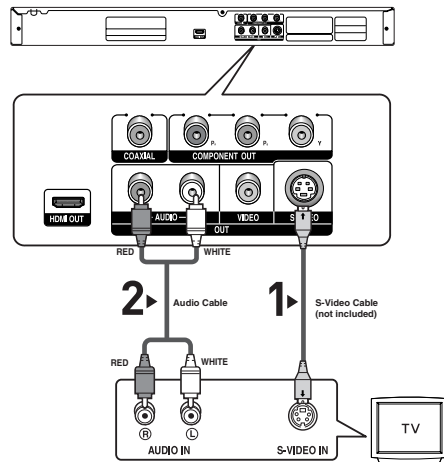

Note

- If you want to connect to an Amplifier, please refer to the Amplifier connection page. (See pages 18 to 19)
- The number and position of terminals may vary depending on the TV set. Please refer to the user's manual of your TV.

CONNECTION

Connection to a TV (Interlace)

- Connecting to your TV using Component video cables.
- You will enjoy high quality and accurate color reproduction images. Component video separates the picture element into black and white(Y), blue(P_B), red(P_R) signals to present clear and clean images. (Audio signals are delivered through the audio output.)

1

Using component video cables (not included), connect the **COMPONENT VIDEO OUT** terminals on the rear of the DVD player to the **COMPONENT IN** terminals of your TV.

2

Using the audio cables, connect the **AUDIO (red and white) OUT** terminals on the rear of the DVD player to the **AUDIO (red and white) IN** terminals of your TV. Turn on the DVD player and TV.

3

Press the input selector on your TV remote control until the Component signal from the DVD player appears on the TV screen.

4

Set the Video Output to **COMPONENT (I-SCAN)** in the Display Setup menu. (See pages 52 to 53)

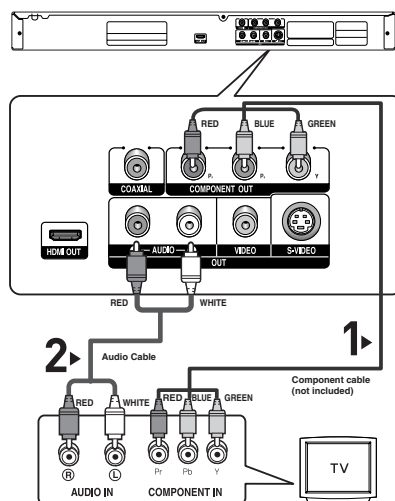

Note

- If Video output is incorrectly set to Composite/S-Video with the Component cables connected, the screen will turn red.
- If you want to connect to an Amplifier, please refer to the Amplifier connection page. (See pages 18 to 19)
- The component terminal of your TV may be marked "R-Y, B-Y, Y" or "Cr, Cb, Y" instead of "P_R, P_B, Y" depending on the manufacturer. The number and location of the terminals may vary depending on the TV set. Please refer to the user's manual of your TV.

CONNECTION

Connection to a TV (Progressive)

1

Using component video cables (not included), connect the **COMPONENT VIDEO OUT** terminals on the rear of the DVD player to the **COMPONENT IN** terminals of your TV.

2

Using the audio cables, connect the **AUDIO (red and white) OUT** terminals on the rear of the DVD player to the **AUDIO (red and white) IN** terminals of your TV. Turn on the DVD player and TV.

3

Press the input selector on your TV remote control until the Component signal from the DVD player appears on the TV screen.

4

Set the Video Output to **HDMI/COMPONENT (P-SCAN)** in the Display Setup menu. (See pages 52 to 53)

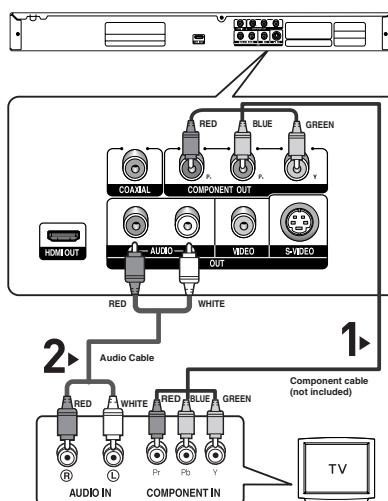

To see the progressive video output,

- Consult your TV User's Manual to find out if your TV supports Progressive Scan. If Progressive Scan is supported, follow the TV User's Manual regarding Progressive Scan settings in the TV's menu system.
- Depending on your TV, the connection method may differ from the illustration above.

Note

- What is "Progressive Scan"?
Progressive scan has twice as many scanning lines as the interlace output method. Progressive scanning method provides better and clearer picture quality.

CONNECTION

Connecting to a TV with DVI Jack

1

Using an HDMI-DVI cable (not included), connect the **HDMI OUT** terminal on the rear of the DVD player to the **DVI IN** terminal of your TV.

2

Using the audio cables, connect the **AUDIO (red and white) OUT** terminals on the rear of the DVD player to the **AUDIO (red and white) IN** terminals of your TV. Turn on the DVD player and TV.

3

Press the input selector on your TV remote control until the DVI signal from the DVD player appears on your TV screen.

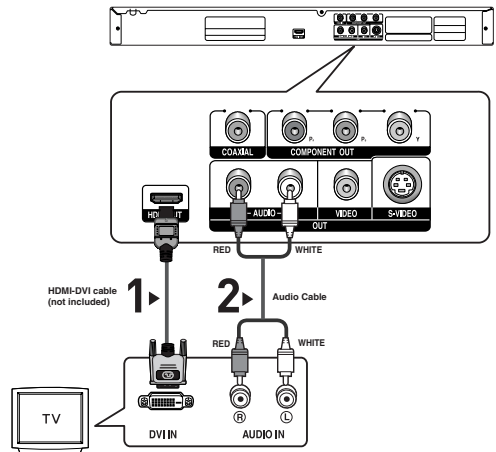

Connecting to a TV with HDMI Jack

1

Using the HDMI-HDMI cable, connect the **HDMI OUT** terminal on the rear of the DVD player to the **HDMI IN** terminal of your TV.

2

Press the input selector on your TV remote control until the HDMI signal from the DVD player appears on your TV screen.

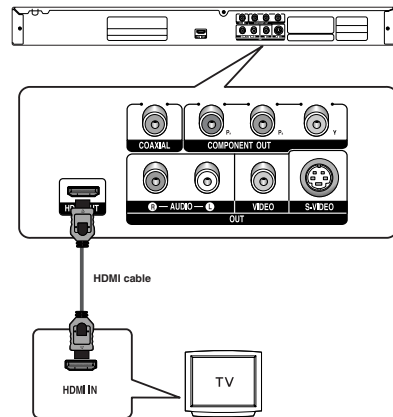

Note

- Depending on your TV, certain HDMI output resolutions may not work.
- Please refer to the user's manual of your TV.
- If HDMI or HDMI-DVI cable is plugged into TV, the DVD player's output is set to HDMI/DVI within 10 seconds.
- If you set the HDMI output resolution 720p or 1080i, the picture quality will improve.

- **HDMI (High Definition Multimedia Interface)**

HDMI is an interface to enable the digital transmission of video and audio data with just a single connector. Using HDMI, the DVD player transmits a digital video and audio signal and displays a vivid picture on a TV having an HDMI input jack.

- **HDMI connection description**

HDMI connector - Both uncompressed video data and digital audio data (LPCM or Bitstream data).

- The player outputs only a pure digital signal to the TV.
- If TV does not support HDCP (High-bandwidth Digital Content Protection), snow noise appears on the screen.

- **Why does Samsung use HDMI?**

Analog TVs require an analog video/audio signal. However, when playing a DVD, the data transmitted to a TV is digital. Therefore either a digital-to-analog converter (in the DVD player) or an analog-to-digital converter (in the TV) is required. During this conversion, the picture quality is degraded due to noise and signal loss. HDMI technology is superior because it requires no D/A conversion and is a pure digital signal from the player to your TV.

- **What is the HDCP?**

HDCP (High-bandwidth Digital Content Protection) is a system for protecting DVD content outputted via HDMI from being copied. It provides a secure digital link between a video source (PC, DVD, etc) and a display device (TV, projector, etc). Content is encrypted at the source device to prevent unauthorized copies from being made.

CONNECTION

Connection to an Audio System (2 Channel Amplifier)

1

Using the audio cables, connect the **AUDIO (red and white) OUT** terminals on the rear of the DVD player to the **AUDIO (red and white) IN** terminals of the Amplifier.

2

Using the video signal cable(s), connect the **VIDEO, S-VIDEO, COMPONENT** or **HDMI OUT** terminals on the rear of the DVD player to the **VIDEO, S-VIDEO, COMPONENT** or **DVI IN** terminal of your TV as described on pages 12 to 16.

3

Turn on the DVD player, TV, and Amplifier.

4

Press the input select button of the Amplifier to select **external input** in order to hear sound from the DVD player. Refer to your Amplifier's user manual to set the Amplifier's audio input.

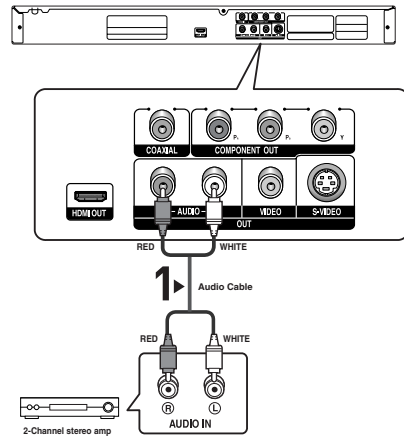

Note

- Please turn the volume down when you turn on the Amplifier. Sudden loud sound may cause damage to the speakers and your ears.
- Please set the audio in the menu screen according to the Amplifier. (See pages 50 to 51)
- The position of terminals may vary depending on the Amplifier. Please refer to the user's manual of the Amplifier.

CONNECTION

Connection to an Audio System (Dolby digital, MPEG2 or DTS Amplifier)

1

If using a coaxial cable (not included), connect the **DIGITAL AUDIO OUT (COAXIAL)** terminal on the rear of the DVD player to the **DIGITAL AUDIO IN (COAXIAL)** terminal of the Amplifier.

2

Using the video signal cable(s), connect the **VIDEO, S-VIDEO, COMPONENT** or **HDMI OUT** terminals on the rear of the DVD player to the **VIDEO, S-VIDEO, COMPONENT** or **DVI IN** terminals of your TV as described on pages 12 to 16.

3

Turn on the DVD player, TV, and Amplifier.

4

Press the input select button of the Amplifier to select **external input** in order to hear sound from the DVD player. Refer to your Amplifier's user manual to set the Amplifier's audio input.

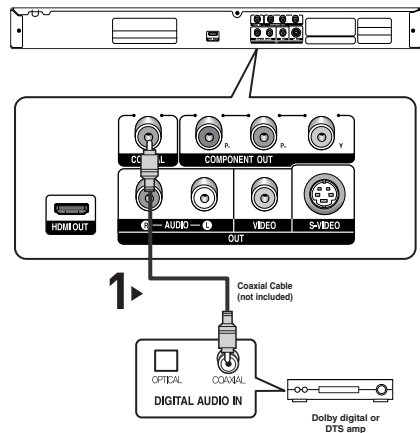

Note

- When you connect the DVD player to a DTS Amplifier and play a DTS disc, set the DTS to On in Audio Setup menu. If it is set to Off, sound will not be heard, or there will be a loud sound.
- Please turn the volume down when you turn on the Amplifier. Sudden loud sound may cause damage to the speakers and your ears.
- Please set the audio in the menu screen according to the Amplifier. (See pages 50 to 51)
- The position of terminals may vary depending on the Amplifier. Please refer to the user's manual of the Amplifier.

Chapter 3

BASIC FUNCTIONS

Playing a Disc

Before Play

- Turn on your TV and set it to the correct Video Input using your TV's remote control.
- If you connected an external Audio System, turn on your Audio System and set it to the correct Audio Input.

After plugging in the player, the first time you press the DVD **POWER** button, this screen appears: If you want to select a language, press a **NUMBER** button. (This screen will only appear when you plug in the player for the first time.) If the language for the startup screen is not set, the settings may change whenever you turn the power on or off. Therefore, make sure that you select the language you want to use.

Once you select a menu language, you can change it by pressing the **▶▶** button on the front panel of the unit for more than 5 seconds with no disc in the unit. Then the **SELECT MENU LANGUAGE** window appears again where you can reset your preferred language.

SELECT MENU LANGUAGE	
Press	1 for English
Touche	2 pour Français
Drücken Sie	3 für Deutsch
Pulsar	4 para Español
Premere	5 per Italiano
Druk op	6 voor Nederlands

Playback

1

Press the **OPEN/CLOSE** (**▲**) button. The **STANDBY** indicator light turns off and the tray opens.



2

Place a disc gently into the tray with the disc's label facing up.



3

Press the **PLAY/PAUSE** (**▶||**) button or **OPEN/CLOSE** (**▲**) button to close the disc tray.



◀ RESUME function

When you stop disc play, the player remembers where you stopped, so when you press **PLAY/PAUSE** (**▶||**) button again, it will pick up where you left off. (unless the disc is removed the player is unplugged, or if you press the **STOP** (**■**) button twice.)

BASIC FUNCTIONS

4

Stopping Play

Press the **STOP** (■) button during play.

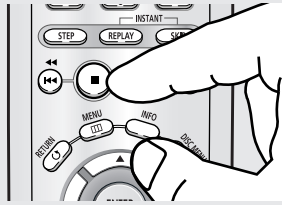

5

Removing Disc

Press the **OPEN/CLOSE** (▲) button.

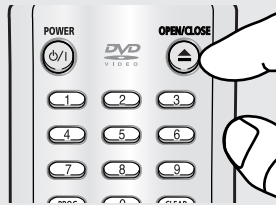

6

Pausing Play

Press the **PLAY/PAUSE** (▶||) or **STEP** button on the remote control during play.

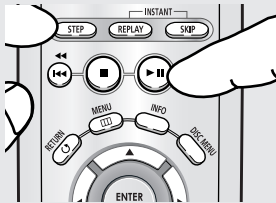

7

Step Motion Play (Except CD)

Press the **STEP** button on the remote control during play.

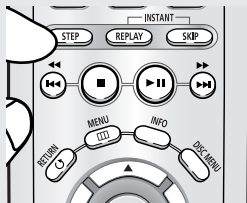

8

Slow Motion Play (Except CD)

Press and hold the **SEARCH** (▶▶) button to choose the play speed between 1/8, 1/4 and 1/2 of normal during PAUSE or STEP mode.

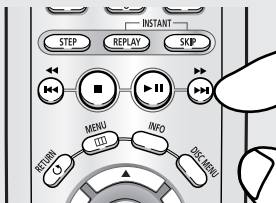

Note

- If the player is left in the stop mode for more than one minute without any user interaction, a screen saver will be activated. Press the **PLAY/PAUSE** (▶||) button to resume normal play.
- If the player is left in the stop mode for more than 30 minutes, the power will automatically turn off. (Automatic Power-Off Function)

- ◀ Screen stops, no sound. To resume, press the **PLAY/PAUSE** (▶||) button once again.

Note

If the player is left for about 5 minutes in pause mode, it will stop.

- ◀ Each time the button is pressed, a new frame will appear. No sound is heard during STEP mode. Press the **PLAY/PAUSE** (▶||) button to resume normal play. You can only perform step motion play in the forward direction.

- ◀ No sound is heard during slow mode. Press the **PLAY/PAUSE** (▶||) button to resume normal play. Reverse slow motion play will not work.

Note

This (⊘) icon indicates the function is not available in the current mode.

BASIC FUNCTIONS

Using the Search and Skip Functions

During play, you can search quickly through a chapter or track, and use the skip function to jump to the next selection.

Searching through a Chapter or Track

During play, press the **SEARCH** (◀ or ▶) button on the remote control for more than 1 second.

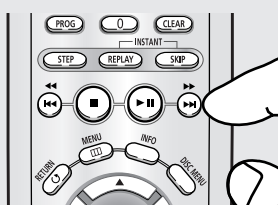

◀ During play, press and hold the **SEARCH** (◀ or ▶) button and press and hold again to search at a faster speed.

DVD	2X, 4X, 64X, 128X
VCD	4X, 8X
CD	2X, 4X, 8X

Note

- The speed marked in this function may be different from the actual playback speed.
- No sound heard during search mode (Except Audio CD).

Skipping Tracks

During play, press the **SKIP** (◀ or ▶) button.

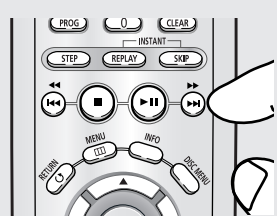

- When playing a DVD, if you press the **SKIP** (▶) button, it moves to the next chapter. If you press the **SKIP** (◀) button, it moves to the beginning of the chapter. One more press makes it move to the beginning of the previous chapter.
- When playing a CD, VCD 1.1 or VCD 2.0 in Menu Off mode, if you press the **SKIP** (▶) button, it moves to the next track. If you press the **SKIP** (◀) button, it moves to the beginning of the track. One more press makes it move to the beginning of the previous track.
- If a track exceeds 15 minutes when playing a VCD and you press the ▶ button, it moves forward 5 minutes. If you press the ◀ button, it moves backward 5 minutes.

Note

When VCD 2.0 is in Menu Off mode only, this function works. Select Menu Off by pressing the **DISC MENU** button.

BASIC FUNCTIONS

Using the Display Function

When Playing a DVD/VCD/CD

1

During play, press the **INFO** button on the remote control.

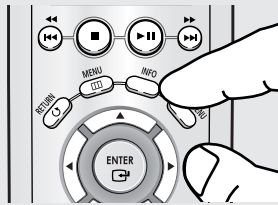

◀ You can also select Info in the function menu by pressing the **MENU** button.

2

Press the **▲/▼** buttons to select the desired item.

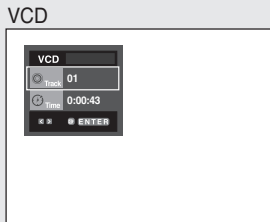

◀ When playing a VCD 2.0, this function works in Menu Off mode only. Select Menu Off by pressing the **DISC MENU** button.

3

Press the **◀▶** buttons to make the desired setup and then press the **ENTER** button.

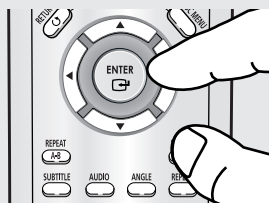

◀ You may use the number buttons of the remote control to directly access a title, chapter or to start the playback from a desired time.





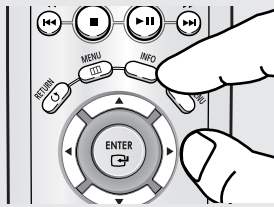

BASIC FUNCTIONS

4

To make the screen disappear, press the **INFO** button again.



Note

	<p>To access the desired title when there is more than one on the disc. For example, if there is more than one movie on a DVD, each movie will be identified.</p>
 	<p>Most DVD discs are recorded in chapters so that you can quickly find a specific passage (similar to tracks on an audio CD).</p>
	<p>Allows playback of the film from a desired time. You must enter the starting time as a reference. The time search function does not operate on some discs.</p>
	<p>Refers to the film's soundtrack language. In the example, the soundtrack is played in English 5.1CH. A DVD disc can have up to eight different soundtracks.</p>
	<p>Refers to the subtitle languages available on the disc. You will be able to choose the subtitle languages or, if you prefer, turn them off from the screen. A DVD disc can have up to 32 different subtitles.</p>

Using the Disc and Title Menu

Using the Disc Menu (DVD)

1

During the playback of a DVD disc, press the **MENU** button on the remote control.

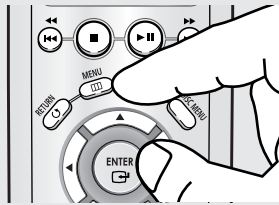

2

Press the ▲/▼ buttons to select **Disc Menu**, then press the ► or **ENTER** button.

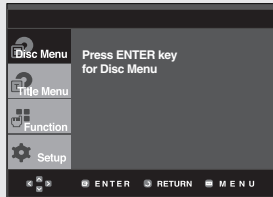

Note

- Depending on the disc, the Disc Menu may not be available.
- You can also use the Disc Menu, using the **DISC MENU** button on the remote control.
- In VCD 2.0 the **DISC MENU** button is used to select Menu On or Menu Off mode.

Using the Title Menu (DVD)

1

During the playback of a DVD disc, press the **MENU** button on the remote control.

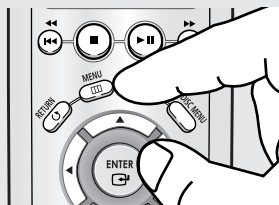

2

Press the ▲/▼ buttons to select **Title Menu**, then press the ► or **ENTER** button.

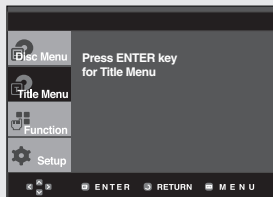

Note

- Depending on the disc, the Title Menu may not be available.
- Title Menu will only be displayed if there are at least two titles in the disc.

Using the Function Menu

Using the Function Menu (DVD/VCD)

1

Press the **MENU** button during playback.

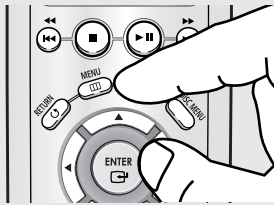

2

Press the ▲/▼ buttons to select **Function**, then press the ► or **ENTER** button.

- Info (See pages 23 to 24)
- Zoom (See page 37)
- Bookmark (See pages 35 to 36)
- Repeat (See pages 27 to 28)
- EZ View (See pages 30 to 31)

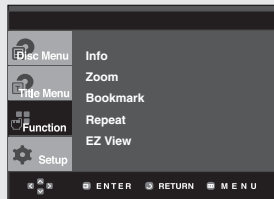

3

Press the ▲/▼ buttons to select one of the five functions. Then press the ► or **ENTER** button to access the function.

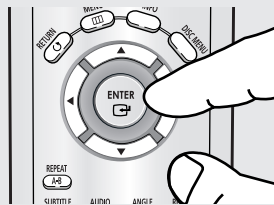

◀ You can also directly select these functions using their respective buttons on the remote control.

Note

- For VCD2.0, this function is available in Menu Off mode only. Select Menu Off by pressing the **DISC MENU** button.

Repeat Play

Repeat the current track, chapter, title, a chosen section (A-B), or all of the disc.

When playing a DVD/VCD/CD

1

During play, press the **REPEAT** button on the remote control. Repeat screen appears.

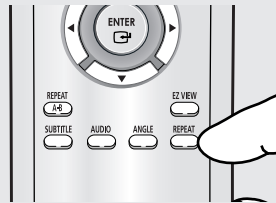

2

Press the ◀▶ buttons to select **Chapter**, **Title** or **A-B**, then press the **ENTER** button.

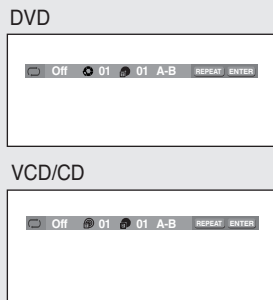

◀ DVD repeats play by chapter or title, CD and VCD repeat play by disc or track.

Chapter (📀): repeats the chapter that is playing.

Title (🎬): repeats the title that is playing.

Disc (📀): repeats the disc that is playing.

Track (🎵): repeats the track that is playing.

A-B: repeats a segment of the disc that you select.

Using the A-B Repeat function

1. Press the **REPEAT A-B** button at the point where you want repeat play to start (A). A is automatically highlighted.
2. Press the **REPEAT A-B** again at the point where you want repeat play to stop (B).
 - To return to normal play, press the **CLEAR** button.

Note

A-B REPEAT does not allow you to set point (B) until at least 5 seconds of playback time has elapsed after point (A) has been set.

3

To return to normal play, press **REPEAT** button again, then press the ◀▶ buttons to select **Off** and press **ENTER** button.

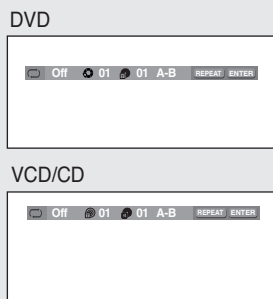

Note

- Depending on a disc, the Repeat function may not be available.
- When playing a VCD 2.0, this function works in Menu Off mode only. Select Menu Off by pressing the **DISC MENU** button.

BASIC FUNCTIONS

Slow Repeat Play

This feature allows you slowly to repeat scenes containing sports, dancing, musical instruments being played etc., so you can study them more closely.

When playing a DVD/VCD

1

During play, press the **PLAY/PAUSE** (▶||) button.



2

Press and hold the **SEARCH** (▶▶) button to choose the play speed between 1/8, 1/4 and 1/2 of normal during PAUSE or STEP mode.

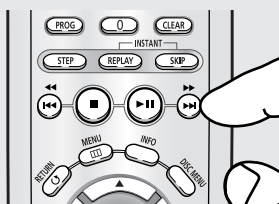

3

Press the **REPEAT** button on the remote control. Press the ◀▶ buttons to select **A-B**.

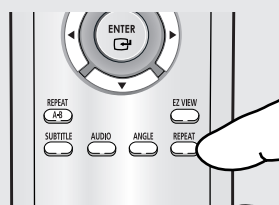

◀ The disc will play from A to B repeatedly at the speed you chose.

4

Press the **ENTER** button at the point where you want repeat play to start (A). A is automatically highlighted. Press the **ENTER** button at the point where you want the repeat play to stop (B).

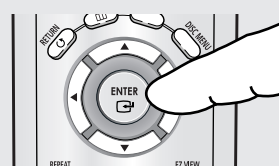

◀ To set A-B REPEAT, set (A) first, then set (B) after the following slow play time has elapsed:
 1/8x: wait 40 seconds, then press B
 1/4x: wait 20 seconds, then press B
 1/2x: wait 10 seconds, then press B

5

To return to normal play, press the **CLEAR** button and then press the **PLAY/PAUSE** (▶||) button.



Note

When playing a VCD 2.0, this function works in Menu Off mode only. Select Menu Off by pressing the **DISC MENU** button.

Using the A-B Repeat function

1. During slow playback, press the **REPEAT A-B** button at the point where you want repeat play to start (A). A is automatically highlighted.
2. Press the **REPEAT A-B** button again at the point where you want the repeat play to stop (B).
 - To return to normal play, press the **CLEAR** button and then press the **PLAY/PAUSE**(▶||) button.

BASIC FUNCTIONS

Program Play & Random Play

Program Play (Audio CD)

Program Play allows you to select the order in which you want tracks to play.

1

During play, press the **PROG** button.

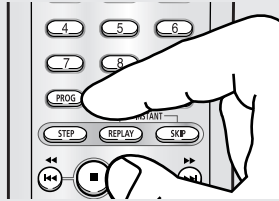

2

Press the ◀▶ buttons to select **PROGRAM**.
Press the **ENTER** button.



3

Press the ▲▼/◀▶ buttons to select the first track to add to the program.
Press the **ENTER** button.
The selection numbers appear in the Program Order box.

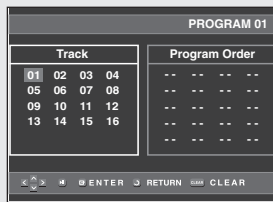

- ◀ - To return to the previous menu screen, press the **RETURN** button.
- To cancel the selected program order, press the **CLEAR** button.
- This unit can support a maximum of 20 programmed tracks.

4

Press the **PLAY/PAUSE** (▶▶) button.
The disc will be played in programmed order.

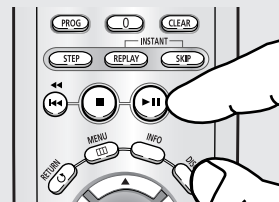

Random Play (CD)

Random Play plays a disc's tracks in random order.

1

Press the **PROG** button.

2

Press the ◀▶ buttons to select **RANDOM**.
Press the **ENTER** button.



Note

- Depending on a disc, the Program and Random Play functions may not be available.
- While in playback mode, press the **CLEAR** button on the remote control to cancel Program Play or Random Play.

Chapter 4

ADVANCED FUNCTIONS

Adjusting the Aspect Ratio (EZ View)

To play back using aspect ratio (DVD)

During play, press the **EZ VIEW** button.

- The screen size changes when the button is pressed repeatedly.
- The screen zoom mode operates differently depending on the screen setting in the Display Setup menu.
- To ensure correct operation of the **EZ VIEW** button, you should set the correct aspect ratio in the Display Setup menu. (See pages 52 to 53).

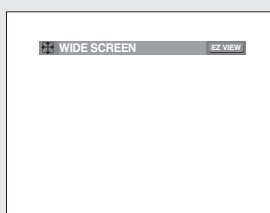
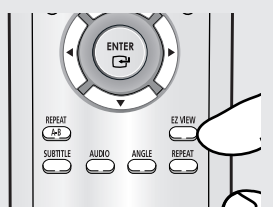

- ◀ To make the aspect ratio bar disappear, press the **CLEAR** or **RETURN** button, or just wait 5 seconds.

If you are using a 16:9 TV

For 16:9 aspect ratio discs

- **WIDE SCREEN**
Displays the content of the DVD title in 16:9 aspect ratio.
- **SCREEN FIT**
The top and bottom portions of the screen are cut off. When playing a 2.35:1 aspect ratio disc, the black bars at the top and bottom of the screen will disappear. The picture will look vertically stretched. (Depending on a type of disc, the black bars may not disappear completely.)
- **ZOOM FIT**
The top, bottom, left and right of the screen are cut off and the central portion of the screen is enlarged.

For 4:3 aspect ratio discs

- **Normal Wide**
Displays the content of the DVD title in 16:9 aspect ratio. The picture will look horizontally stretched.
- **SCREEN FIT**
The top and bottom portions of the screen are cut off and the full screen appears. The picture will look vertically stretched.
- **ZOOM FIT**
The top, bottom, left and right portions of the screen are cut off and the central portion of the screen is enlarged.
- **Vertical Fit**
When a 4:3 DVD is viewed on a 16:9 TV, black bars will appear at the left and right of the screen in order to prevent the picture from looking horizontally stretched.

ADVANCED FUNCTIONS

If you are using a 4:3 TV

For 16:9 aspect ratio discs

- 4:3 Letter Box

Displays the content of the DVD title in 16:9 aspect ratio. The black bars will appear at the top and bottom of the screen.

- 4:3 Pan & Scan

The left and right portions of the screen are cut off and the central portion of the 16:9 screen is displayed.

- SCREEN FIT

The top and bottom portions of the screen are cut off and a full screen appears. The picture will look vertically stretched.

- ZOOM FIT

The top, bottom, left and right of the screen are cut off and the central portion of the screen is enlarged.

For 4:3 aspect ratio discs

- Normal Screen

Displays the content of the DVD title in 4:3 aspect ratio.

- SCREEN FIT

The top and bottom portions of the screen are cut off and the full screen appears.

The picture will look vertically stretched.

- ZOOM FIT

The top, bottom, left and right portions of the screen are cut off and the central portion of the screen is enlarged.

Note

EZ View may behave differently depending on the type of disc.

Selecting the Audio Language

You can select a desired audio language quickly and easily with the **AUDIO** button.

Using the AUDIO button (DVD/VCD/CD)

1

During play, press the **AUDIO** button.
The Audio changes when the button is pressed repeatedly.
- The audio languages are represented by abbreviations.

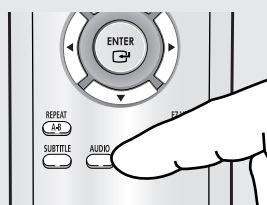

DVD



When playing a VCD or CD, you can select among **Stereo, Right** or **Left**.

VCD/CD



2

To remove the **AUDIO** icon, press the **CLEAR** or **RETURN** button.

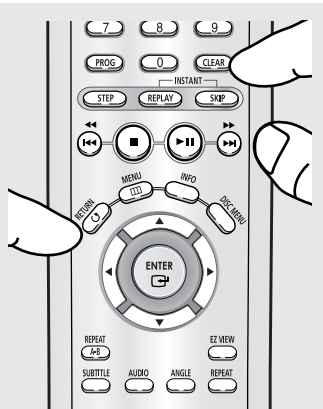

Note

- This function depends on audio languages that are encoded on the disc and may not be available.
- A DVD disc can contain up to 8 audio languages.
- To have the same audio language come up whenever you play a DVD, refer to "Using the Audio Language" on page 48.

Selecting the Subtitle Language

You can select a desired subtitle quickly and easily with the **SUBTITLE** button.

Using the SUBTITLE button (DVD)

1

Press the **SUBTITLE** button.
The subtitle changes when the button is pressed repeatedly.
The subtitle languages are represented by abbreviations.

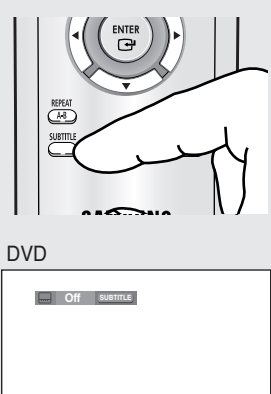

DVD

Off SUBTITLE

2

To remove the **SUBTITLE** icon, press the **CLEAR** or **RETURN** button.

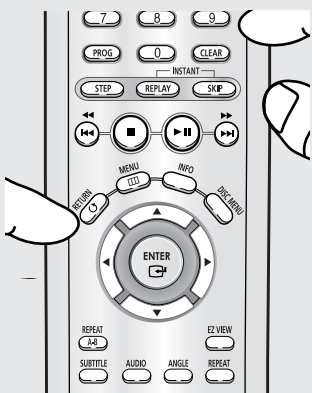

Note

- Depending on the DVD, you can change desired subtitle in the Disc Menu. Press the **DISC MENU** button.
- This function depends on what subtitles are encoded on the disc and may not be available on all DVDs.
- A DVD disc can contain up to 32 subtitle languages.
- To have the same subtitle language come up whenever you play a DVD; Refer to "Using the Subtitle Language" on page 49.

Changing the Camera Angle

When a DVD contains multiple angles of a particular scene, you can use the ANGLE function.

Using the ANGLE button (DVD)

If the disc contains multiple angles, the ANGLE icon appears on the screen.

1

Press the **ANGLE** button, then the ANGLE icon will appear with the current angle number and the number of angles available.

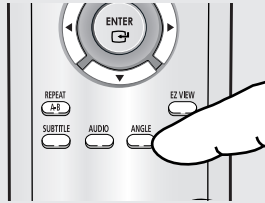

2

Press the **ANGLE** button repeatedly to select the desired angle. To remove the ANGLE icon, press the **CLEAR** or **RETURN** button.

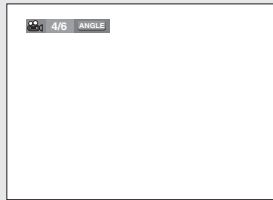

Note

If the disc has only one angle, this feature won't work. Currently, very few discs have this feature.

Using the Instant Replay/Skip Function

Using the Instant Replay function (DVD)

If you miss a scene, you can see it again using this function.

Press the **INSTANT REPLAY** button.
 - The current scene moves backward about 10 seconds, and plays back.



Using the Instant Skip function (DVD)

Use this function to skip playback about 10 seconds ahead of the current scene.

Press the **INSTANT SKIP** button.
 - Playback will skip ahead 10 seconds.



Note

Depending on the disc, these functions may not work.

Using the Bookmark Function

This feature lets you bookmark sections of a DVD or VCD (Menu Off mode), so you can quickly find them at a later time.

Using the Bookmark Function (DVD/VCD)

1

During play, press the **MENU** button on the remote control.

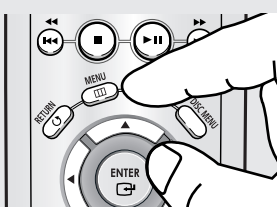

2

Press the ▲/▼ buttons to select **Function**, then press the ► or **ENTER** button.

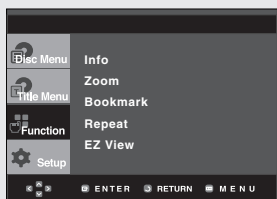

3

Press the ▲/▼ buttons to select **Bookmark**, then press the ► or **ENTER** button.

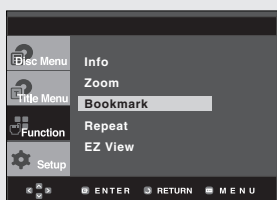

4

When you reach the scene you want to mark, press the **ENTER** button. Up to three scenes may be marked at a time.

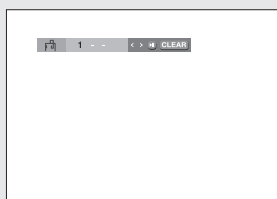
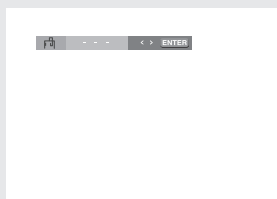

Note

- When playing VCD 2.0, this function works only when the menu is off.
- Depending on a disc, the Bookmark function may not work.

ADVANCED FUNCTIONS

Recalling a Bookmarked Scene

1~3

The first 1~3 steps are the same as those for "Using the Bookmark Function" on page 35.

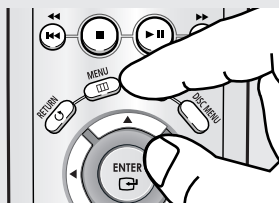

4

Press the ◀▶ buttons to select a marked scene.



5

Press the **PLAY/PAUSE** (▶||) button to Play the marked scene.

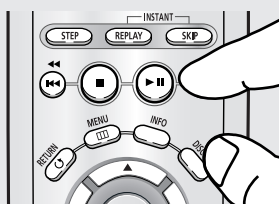

Clearing a Bookmark

1~3

The first 1~3 steps are the same as those for "Using the Bookmark Function" on page 35.

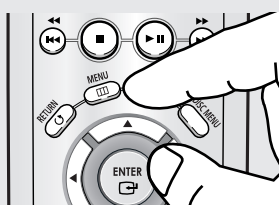

4

Press the ◀▶ buttons to select the bookmark number you want to delete.

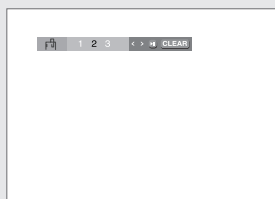

5

Press the **CLEAR** button to delete a bookmark number.

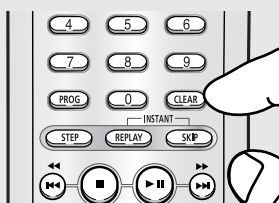

Using the Zoom Function

Using the Zoom Function (DVD/VCD)

1
During play or pause mode, press the **MENU** button on the remote control.

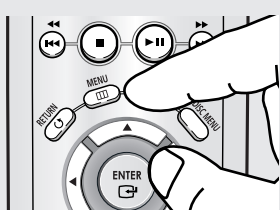

2
Press the ▲/▼ buttons to select **Function**, then press the ► or **ENTER** button.

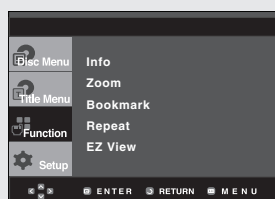

3
Press the ▲/▼ buttons to select **Zoom**, then press the ► or **ENTER** button.

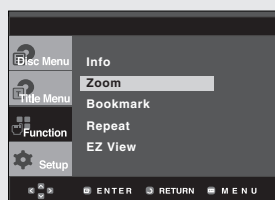

4
Press the ▲/▼ or ◀/▶ buttons to select the part of the screen you want to zoom in on. Press the **ENTER** button.

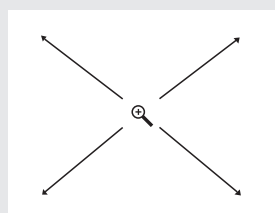

◀ During DVD play, press **ENTER** to zoom in 2X/4X/2X/Normal in order.
During VCD play, press **ENTER** to zoom in 2X/Normal in order.

Note
For VCD2.0, this function works in Menu Off mode only. Select Menu Off by pressing the **DISC MENU** button.

ADVANCED FUNCTIONS

Clips Menu for MP3/WMA/JPEG

Discs with MP3/WMA/JPEG contain individual songs and/or pictures that can be organized into folders as shown below. They are similar to how you use your computer to put files into different folders.

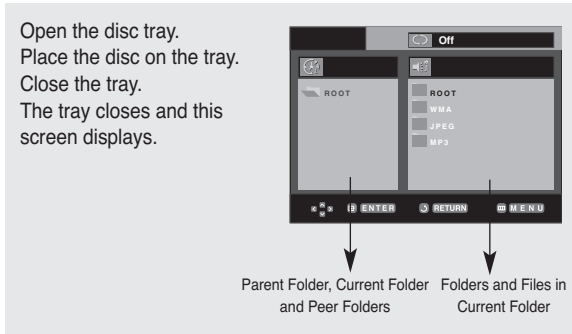

- : Name of currently playing file.
- : Current Playback Time.
- : Current Playback Mode : There are four modes. They can be selected in order by pressing the **REPEAT** button.
 - Off: Normal Playback
 - Track: Repeats the current track.
 - Folder: Repeats the current folder.
 - Random: Files in the disc will be played in random order.
- : MP3 file icon.
- : WMA file icon.
- : JPEG file icon.
- : Folder icon.
- : Current Folder icon.

Folder Selection

The folder can only be selected in the Stop mode.

- **To select the Parent Folder**
Press the **RETURN** button to go to the parent folder, or press the **▲/▼** buttons to select ".." and press **ENTER** to go to the parent folder.
- **To select the Peer Folder**
Press the **◀/▶** buttons to highlight the left window. Press the **▲/▼** buttons to select the desired folder, then press **ENTER**.
- **To select the Sub-Folder**
Press the **◀/▶** buttons to highlight the right window. Press the **▲/▼** buttons to select the desired folder, then press **ENTER**.

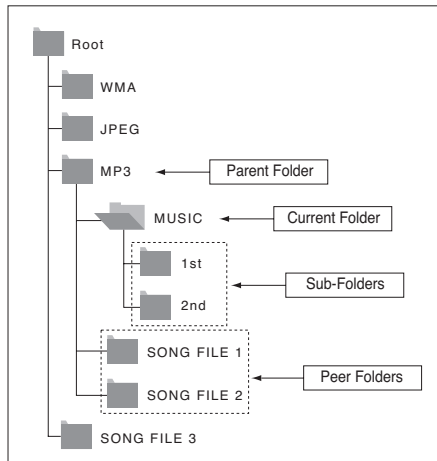

MP3/WMA Playback

1

Open the disc tray.
Place the disc on the tray.
Close the tray.

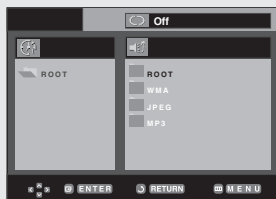

2

Press the ▲/▼ or ◀/▶ buttons to select a song file.
Press **ENTER** to begin playback of the song file.

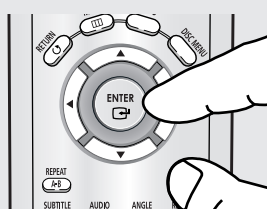

◀ When a disc contains MP3 and WMA files, only MP3 will play, not both.

Repeat/Random playback

1

Press the **REPEAT** button to change the playback mode. There are four modes; **Off**, **Track**, **Folder** and **Random**.

- Off: Normal Playback
- Track: Repeats the current song file.
- Folder: Repeats the song files which have the same extension in the current folder.
- Random: Song files which have the same extension will be played in random order.

To resume normal play, press the **CLEAR** button.

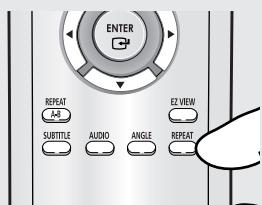

ADVANCED FUNCTIONS

CD-R MP3/WMA file

When you record MP3 or WMA files on CD-R, please refer to the following.

- Your MP3 or WMA files should be ISO 9660 or JOLIET format.

ISO 9660 format and Joliet MP3 or WMA files are compatible with Microsoft's Windows, and with Apple's Mac. This format is the most widely used.

- When naming your MP3 or WMA files, do not exceed 8 characters, and enter ".mp3, .wma" as the file extension.

General name format : Title.mp3. or Title.wma. When composing your title, make sure that you use 8 characters or less, have no spaces in the name, and avoid the use of special characters including: (,./,\,=,+).

- Use a compression rate of at least 128 Kbps when recording MP3 files.

Sound quality with MP3 files basically depends on the rate of compression you choose. Getting CD audio sound requires an analog/digital sampling rate, that is converted to MP3 format, of at least 128 Kbps and up to 160 Kbps. However, choosing higher rates, like 192 Kbps or more, only rarely give better sound quality. Conversely, files with decompression rates below 128 Kbps will not be played properly.

- Use a decompression transfer rate of at least 64Kbps when recording WMA files.

Sound quality with WMA files basically depends on the rate of compression you choose.

Getting CD audio sound requires an analog/digital sampling rate, of 64Kbps and up to 192Kbps.

Conversely, files with decompression rates below 64Kbps or over 192Kbps will not be played properly.

- Do not try recording copyright protected MP3 files.

Certain "secured" files are encrypted and code protected to prevent illegal copying. These files are of the following types: Windows Media™ (registered trade mark of Microsoft Inc) and SDMI™ (registered trade mark of The SDMI Foundation). You cannot copy such files.

- Important:

The above recommendations cannot be taken as a guarantee that the DVD player will play MP3 recordings, or as an assurance of sound quality. You should note that certain technologies and methods for MP3 file recording on CD-Rs prevent optimal playback of these files on your DVD player (degraded sound quality and in some cases, inability of the player to read the files).

- This unit can play a maximum of 3000 files and 300 folders per disc.

Picture CD Playback

1

Press the ▲/▼ buttons to select the desired Folder, then press **ENTER**.

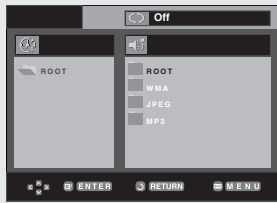

2

Press the ▲/▼ buttons to select a Picture file in the clips menu and then press the **ENTER** button.

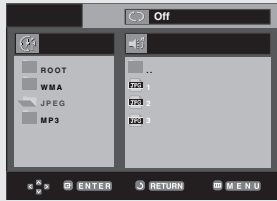

3

Press the **INFO** button to display the menu. Press the ◀/▶ buttons to select the menu you want to view, then press the **ENTER** button.

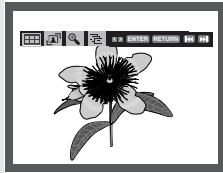

Note

- If no buttons on the remote control are pressed for 10 seconds, the menu will disappear.
- Press the **STOP** button to return to the clips menu.
- When playing a Kodak Picture CD, the unit displays the Photo directly, not the clips menu.

Album Screen

-  : Returns to the Album Screen.
- To see the next six pictures, press the ▶▶ button.
- To see the previous six pictures, press the ◀◀ button.

Rotation

-  : Each time the **ENTER** button is pressed, the picture rotates 90 degrees clockwise.

Zoom





-  : Press the ▲/▼ or ◀/▶ buttons to select the part of the screen you want to zoom in on. Press the **ENTER** button. Each time the **ENTER** button is pressed, the picture is enlarged up to 4X. (2X → 4X → 2X → Normal)

Note

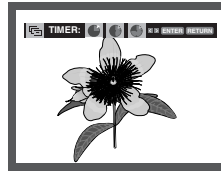
- Depending on a file size, the amount of time between each picture may be different from the set interval time.
- If you don't press any button, the slide show will start automatically in about 10 seconds by default.

Slide Show



-  : The unit enters slide show mode.
- Before beginning the Slide Show, set the picture interval. Press the ◀/▶ buttons to select a desired icon, then press the **ENTER** button.
-  : The pictures change automatically with about a 6 second interval.
-  : The pictures change automatically with about a 12 second interval.
-  : The pictures change automatically with about a 18 second interval.

ADVANCED FUNCTIONS

CD-R JPEG Discs

- Only files with the “.jpg” and “.JPG” extensions can be played.
- If the disc is not closed, it will take longer to start playing and not all of the recorded files may be played.
- Only CD-R discs with JPEG files in ISO 9660 or Joliet format can be played.
- The name of the JPEG file may not be longer than 8 characters and should contain no blank spaces or special characters (. / = +).
- Only a consecutively written multi-session disc can be played. If there is a blank segment in the multi-session disc, the disc can be played only up to the blank segment.
- A maximum of 3000 images can be stored on a single CD.
- Kodak Picture CDs are recommended.
- When playing a Kodak Picture CD, only the JPEG files in the pictures folder can be played.
- Kodak Picture CD: The JPEG files in the pictures folder can be played automatically.
- Konica Picture CD: If you want to see the Picture, select the JPEG files in the clips menu.
- Fuji Picture CD: If you want to see the Picture, select the JPEG files in the clips menu.
- QSS Picture CD: The unit may not play QSS Picture CD.
- If the number of files in 1 Disc is over 3000, only 3000 JPEG files can be played.
- If the number of folders in 1 Disc is over 300, only JPEG files in 300 folders can be played.

Chapter 5

CHANGING SETUP MENU

Using the Setup Menu

The Setup menu lets you customize your DVD player by allowing you to select various language preferences, set up a parental level, even adjust the player to the type of television screen you have.

1

With the unit in Stop mode, press the **MENU** button on the remote control. Press the **▲/▼** buttons to select **Setup**, then press the **▶** or **ENTER** button.

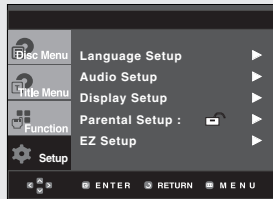

- ❶ Language Setup : Setup of the Language.
- ❷ Audio Setup : Setup of the Audio Options.
- ❸ Display Setup : Setup of the Display Options. Use to select which type of screen you want to watch and several display options.
- ❹ Parental Setup : Setup of the Parental Level. Allows users to set the level necessary to prevent children from viewing unsuitable movies such as those with violence, adult subject matter, etc.
- ❺ EZ Setup : Using the EZ Setup, you can setup PLAYER MENU LANGUAGE, TV Aspect, and PCM Down Sampling in a single menu to suit your preference.

2

Press the **▲/▼** buttons to access the different features. Press the **▶** or **ENTER** button to access the sub features.

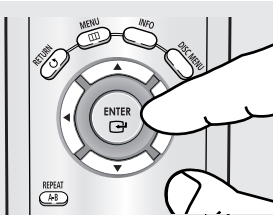

3

To make the setup screen disappear after setting up, press the **MENU** button again.

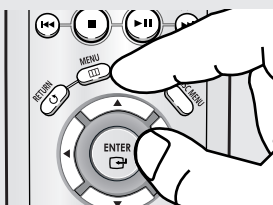

Note

Depending on the disc, some Setup menu selections may not be available.

CHANGING SETUP MENU

Setting Up EZ-Setup

Using the EZ Setup, you can setup PLAYER MENU LANGUAGE, TV Aspect, and PCM Down Sampling in a single menu to suit your preference.

1

With the unit in Stop mode, press the **MENU** button.

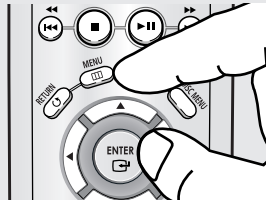

2

Press the **▲/▼** buttons to select **Setup**, then press the **▶** or **ENTER** button.

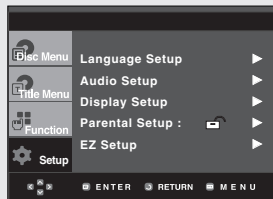

3

Press the **▲/▼** buttons to select **EZ Setup**, then press the **▶** or **ENTER** button.

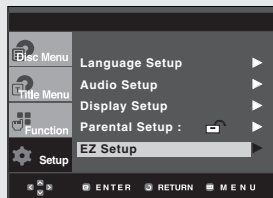

4

To begin **EZ Setup**, press the **▲/▼** buttons to select **Yes**, then press the **ENTER** button.

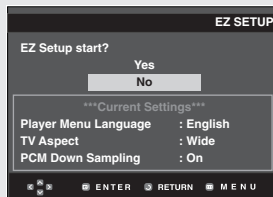

5

Press the **▲/▼** buttons to select the desired player menu language, then press the **ENTER** button.



CHANGING SETUP MENU

6

Press the ▲/▼ buttons to select the desired TV Aspect, then press the **ENTER** button.
(See page 53)

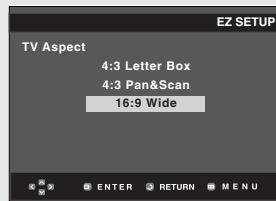

7

Press the ▲/▼ buttons to select the PCM Down Sampling **On** or **Off**, then press the **ENTER** button.
(See page 51)

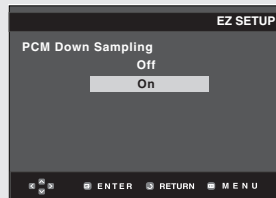

8

Press the **ENTER** button to finish.



◀ To exit the setup menu, press the **MENU** button.

CHANGING SETUP MENU

Setting Up the Language Features

If you set the player menu, disc menu, audio and subtitle language in advance, they will come up automatically every time you watch a movie.

Using the Player Menu Language

1

With the unit in Stop mode, press the **MENU** button.

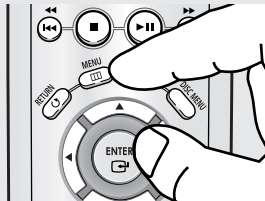

2

Press the ▲/▼ buttons to select **Setup**, then press the ► or **ENTER** button.

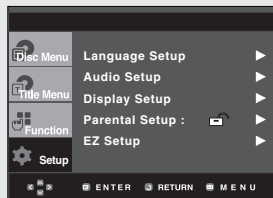

3

Press the ▲/▼ buttons to select **Language Setup**, then press the ► or **ENTER** button.

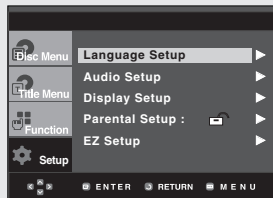

4

Press the ▲/▼ buttons to select **Player Menu**, then press the ► or **ENTER** button.

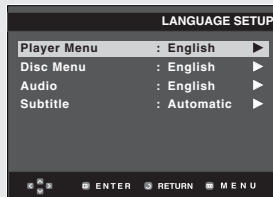

5

Press the ▲/▼ buttons to select the desired language, then press the ► or **ENTER** button.

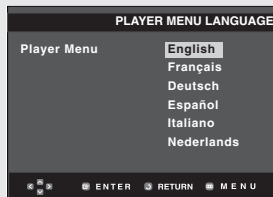

- ◀ - The language is selected and the screen returns to Language Setup menu.
- To exit the setup menu, press the **MENU** button.

CHANGING SETUP MENU

Using the Disc Menu Language

This function changes the text language only on the disc menu screens.

1

With the unit in Stop mode, press the **MENU** button.

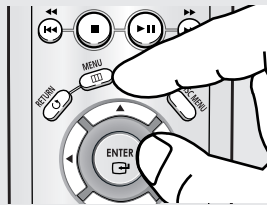

2

Press the ▲/▼ buttons to select **Setup**, then press the ► or **ENTER** button.

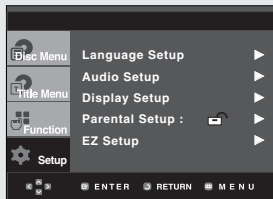

3

Press the ▲/▼ buttons to select **Language Setup**, then press the ► or **ENTER** button.

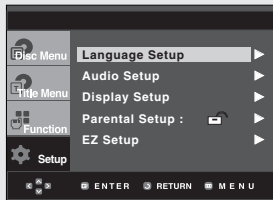

4

Press the ▲/▼ buttons to select **Disc Menu**, then press the ► or **ENTER** button.

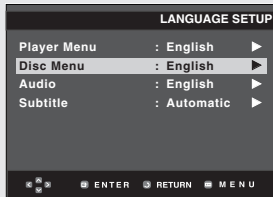

5

Press the ▲/▼ buttons to select the desired language, then press the ► or **ENTER** button.

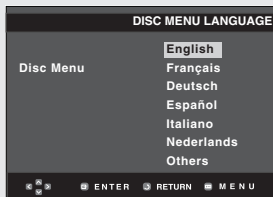

- ◀ - Select "Others" if the language you want is not listed.
- If the selected language is not recorded on the disc, the original pre-recorded language is selected.
- The language is selected and the screen returns to Language Setup menu.
- To exit the setup menu, press the **MENU** button.

CHANGING SETUP MENU

Using the Audio Language

1

With the unit in Stop mode, press the **MENU** button.

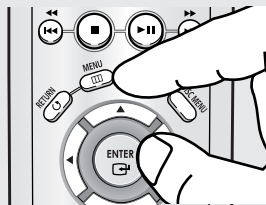

2

Press the ▲/▼ buttons to select **Setup**, then press the ► or **ENTER** button.

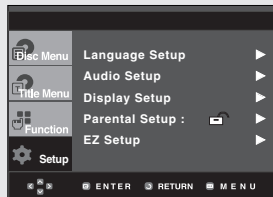

3

Press the ▲/▼ buttons to select **Language Setup**, then press the ► or **ENTER** button.

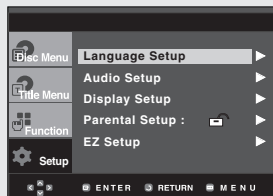

4

Press the ▲/▼ buttons to select **Audio**, then press the ► or **ENTER** button.



5

Press the ▲/▼ buttons to select the desired language, then press the ► or **ENTER** button.

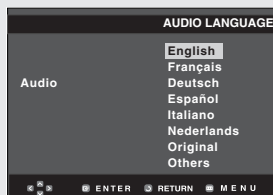

- ◀ - Select "Original" if you want the default soundtrack language to be the original language the disc is recorded in.
- Select "Others" if the language you want is not listed.
- If the selected language is not recorded on the disc, the original pre-recorded language is selected.
- The language is selected and the screen returns to Language Setup menu.
- To exit the setup menu, press the **MENU** button.

CHANGING SETUP MENU

Using the Subtitle Language

1

With the unit in Stop mode, press the **MENU** button.

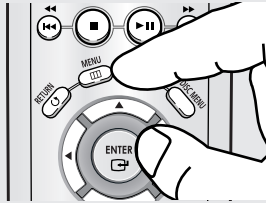

2

Press the ▲/▼ buttons to select **Setup**, then press the ► or **ENTER** button.

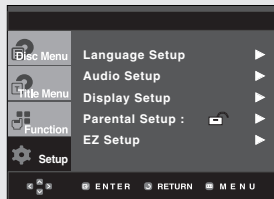

3

Press the ▲/▼ buttons to select **Language Setup**, then press the ► or **ENTER** button.

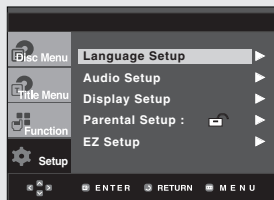

4

Press the ▲/▼ buttons to select **Subtitle**, then press the ► or **ENTER** button.

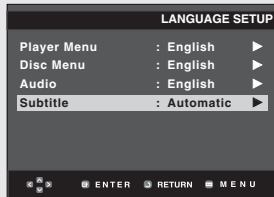

5

Press the ▲/▼ buttons to select the desired language, then press the ► or **ENTER** button.

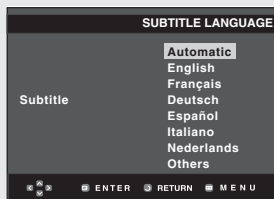

- ◀ - Select "Automatic" if you want the subtitle language to be the same as the language selected as the audio language.
- Select "Others" if the language you want is not listed. Some discs may not contain the language you select as your initial language; in that case the disc will use its original language setting.
- The language is selected and the screen returns to setup menu.
- To exit the setup menu, press the **MENU** button.

CHANGING SETUP MENU

Setting Up the Audio Options

Audio Options allow you to set up the audio device and sound status settings depending on the audio system in use.

1

With the unit in Stop mode, press the **MENU** button.

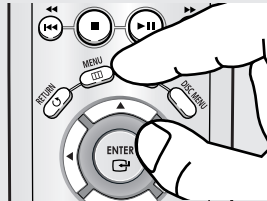

2

Press the **▲/▼** buttons to select **Setup**, then press the **▶** or **ENTER** button.

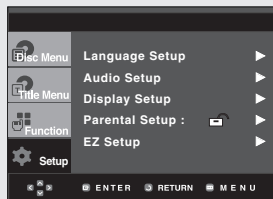

3

Press the **▲/▼** buttons to select **Audio Setup**, then press the **▶** or **ENTER** button.

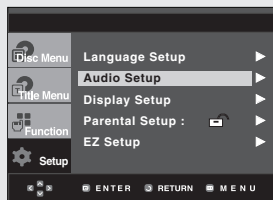

4

Press the **▲/▼** buttons to select the desired item, then press the **▶** or **ENTER** button.

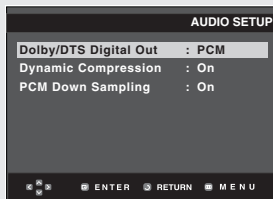

◀ To exit the setup menu, press the **MENU** button.

CHANGING SETUP MENU

❶ Dolby/DTS Digital Out

- PCM : Converts to PCM(2CH) audio.
- Bitstream : Outputs Dolby Digital or DTS Bitstream via digital output.
Select Bitstream when connecting to a Dolby Digital and DTS Decoder.

Note

- There is no analog audio output when you play a DTS disc.

❷ Dynamic Compression

- On : To select dynamic compression.
- Off : To select the standard range.

❸ PCM Down Sampling

- On : Select this when the Amplifier connected to the player is not 96KHz compatible.
In this case, the 96KHz signals will be down converted to 48KHZ.
- Off : Select this when the Amplifier connected to the player is 96KHz compatible. In this case, all signals will be output without any changes.

Note

Even when PCM Down sampling is Off, some discs will only output down sampled audio through the digital outputs.

HDMI

- If your TV is not compatible with compressed multi-channel formats (Dolby Digital, DTS, MPEG), you should set Digital Audio to PCM.
- If your TV is not compatible with LPCM sampling rates over 48kHz, you should set PCM Down sampling to On.

Note

- To exit the setup menu, press the **MENU** button.

Manufactured under license from Dolby Laboratories. "Dolby" and the double-D symbol are trademarks of Dolby Laboratories.

"DTS" and "DTS Digital Out" are trademarks of Digital Theater Systems, Inc.

CHANGING SETUP MENU

Setting Up the Display Options

Display options enable you to set various video functions of the player.

1

With the unit in Stop mode, press the **MENU** button.

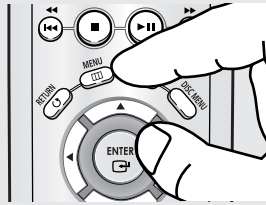

2

Press the ▲/▼ buttons to select **Setup**, then press the ► or **ENTER** button.

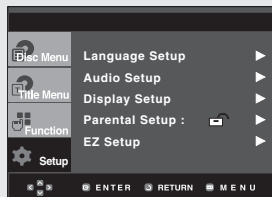

3

Press the ▲/▼ buttons to select **Display Setup**, then press the ► or **ENTER** button.

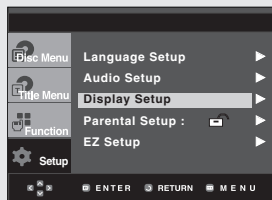

4

Press the ▲/▼ buttons to select the desired item, then press the ► or **ENTER** button.

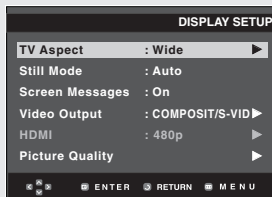

◀ To exit the setup menu, press the **MENU** button.

CHANGING SETUP MENU

1 TV Aspect

Depending on a type of television you have, you may want to adjust the screen setting (aspect ratio).

- 4:3 Letter Box : Select when you want to see the total 16:9 ratio screen DVD supplies, even though you have a TV with a 4:3 ratio screen. Black bars will appear at the top and bottom of the screen.
- 4:3 Pan & Scan : Select this for conventional size TVs when you want to see the central portion of the 16:9 screen. (Extreme left and right side of movie picture will be cut off.)
- 16:9 Wide : You can view the full 16:9 picture on your wide screen TV.



2 Still Mode

These options will help prevent picture shake in still mode and display small text clearer.

- Auto : When selecting Auto, Field/Frame mode will be automatically converted.
- Field : Select this feature when the screen shakes in the Auto mode.
- Frame : Select this feature when you want to see small letters more clearly in the Auto mode.

3 Screen Messages

Use to turn on-screen messages On or Off.

4 Video Output

Select Video Output.

- COMPOSITE/S-VIDEO : Select when you want to use Video and S-Video Out.
- COMPONENT(I-SCAN) : Select when you want to use Video and Component 525i(Interlace) Out.
- HDMI / COMPONENT(P-SCAN) : Select when you want to use Component 525p(Progressive) Out or HDMI.
- If the Yes/No selection in the Display Setup sub Menu is not made within 10 seconds, the screen returns to the previous menu.

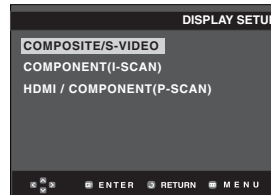
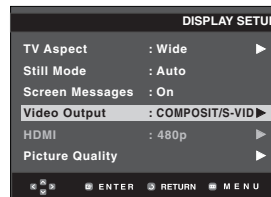

CHANGING SETUP MENU

5 HDMI

This setting is used when the unit is connected by HDMI or DVI to Display devices (TV, Projector, etc.).

- Resolution Setting

- Auto : Resolution setting automatically
- Manual : Resolution setting manually

- Resolution

- 480p : 720 x 480
- 720p : 1280 x 720
- 768p : 1024 x 768
- 1080i : 1920 x 1080

- Format

You can use this function to set HDMI or DVI output's digital data RGB range.

- RGB-Normal : HDMI/DVI Limited range RGB data output. This should be used for TVs.
- RGB-Expand : HDMI/DVI Full range RGB data output. This should be used for PC Monitors.
- YCbCr-(4:4:4) : HDMI Limited range YCbCr-(4:4:4) output.
- YCbCr-(4:2:2) : HDMI Limited range YCbCr-(4:2:2) output.

If you set the HDMI output resolution to 768p, you cannot use YCbCr format.

Limited range - Black/White and color level are displayed within a Limited data range.

- ex) When the bit depth is 8 bits
- Y : 16~235 - levels of brightness
 - CbCr : 16~240 - levels of color

Full range - Black/White and color level are expressed within full data range.

- ex) When the bit depth is 8 bits
- Y : 0~255 - levels of brightness
 - CbCr : 0~255 - levels of color

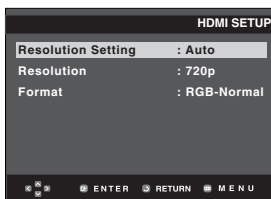

- DVI Output

You can use this function to set HDMI to DVI output format.

When the HDMI to DVI cable is plugged into a TV, you can select either Mode A or Mode B to set up the DVI output.

- This function corrects a TV screen when it is not centered to secure a normal view.
- If HDMI to DVI Output is set incorrectly, the screen can be biased.

6 Picture Quality

- Black Level : Adjusts the brightness of the screen. (On or Off) It does not operate in Progressive scan mode.
- Sharpness : Level 1 ~ Level 5
- Brightness : Level 1 ~ Level 5
- Color Saturation : Level 1 ~ Level 5

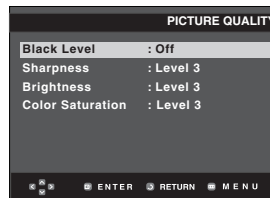

- Color Saturation is only available through the analog outputs.

It is not possible to adjust the Color Saturation in HDMI Mode.

- **Consult your TV User's Manual to find out if your TV supports Progressive Scan. If Progressive Scan is supported, follow the TV User's Manual regarding Progressive Scan settings in the TV's menu system.**
- **If Video Output is set incorrectly, the screen may be distorted.**
- **The resolutions available for HDMI output depend on the connected TV or projector. For details, see the user's manual of your TV or projector.**
- **When the resolution is changed during playback, it may take a few seconds for a normal image to appear.**
- **If you set the HDMI output resolution to 720p or 1080i, HDMI output provides better picture quality.**

Setting Up the Parental Control

The Parental Control function works in conjunction with DVDs that have been assigned a rating, which helps you control the types of DVDs that your family watches. There are up to 8 rating levels on a disc.

1

With the unit in Stop mode, press the **MENU** button.

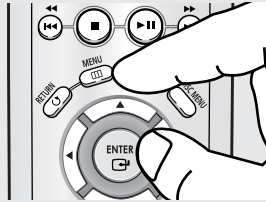

2

Press the **▲/▼** buttons to select **Setup**, then press the **▶** or **ENTER** button.

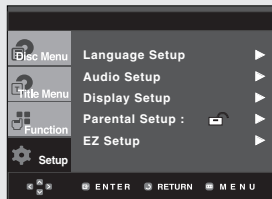

3

Press the **▲/▼** buttons to select **Parental Setup**, then press the **▶** or **ENTER** button.

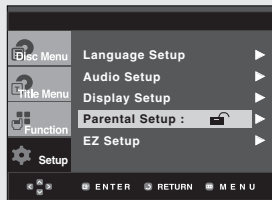

4

Press the **▶** or **ENTER** button to select **Yes** if you want to use a password. The Enter Password screen appears.

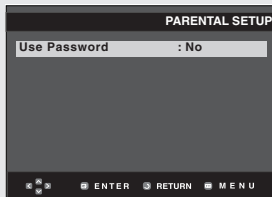

5

Enter your password. The Re-enter Password screen appears to confirm the password. Enter your password again. The player is locked (🔒).

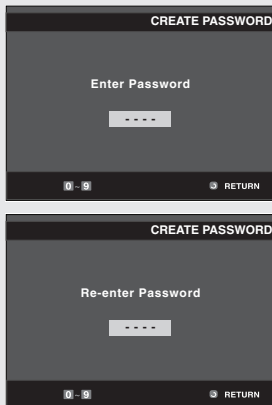

◀ To exit the setup menu, press the **MENU** button.

CHANGING SETUP MENU

Setting Up the Rating Level

1

With the unit in Stop mode, press the **MENU** button.

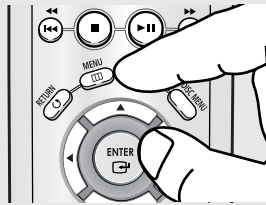

2

Press the ▲/▼ buttons to select **Setup**, then press the ► or **ENTER** button.

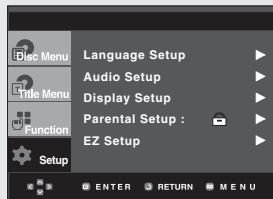

3

Press the ▲/▼ buttons to select **Parental Setup**, then press the ► or **ENTER** button.

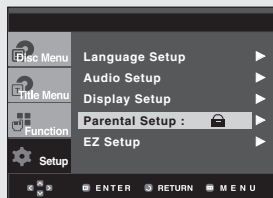

4

Enter your password.

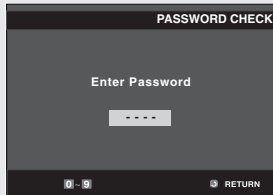

5

Press the ▲/▼ buttons to select **Rating Level**, then press the ► or **ENTER** button.

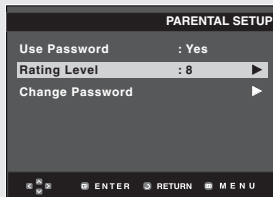

6

Press the ▲/▼ buttons to select the Rating Level you want, then press the ► or **ENTER** button. e.g.) Setting up in **Level 6**.



◀ To exit the setup menu, press the **MENU** button.

For example, if you select up to Level 6, discs that contain Level 7, 8 will not play.

CHANGING SETUP MENU

Changing the Password

1

With the unit in Stop mode, press the **MENU** button.

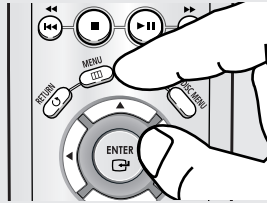

2

Press the ▲/▼ buttons to select **Setup**, then press the ► or **ENTER** button.

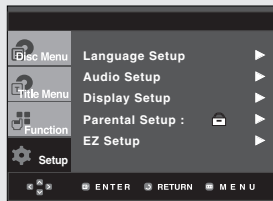

3

Press the ▲/▼ buttons to select **Parental Setup**, then press the ► or **ENTER** button. The Enter Password screen appears. Enter your password.

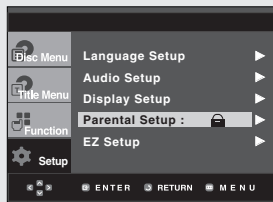

4

Press the ▲/▼ button to select **Change Password**, then press the ► or **ENTER** button. Enter your new password. Re-enter the new password again.

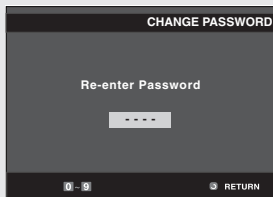
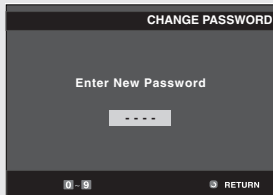
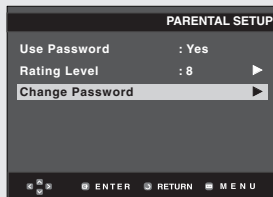

◀ To exit the setup menu, press the **MENU** button.

Note

If you have forgotten your password, see "Forgot Password" in the Troubleshooting Guide. (See page 58)

Chapter 6

REFERENCE

Troubleshooting

Before requesting service (troubleshooting), please check the following.

Problem	Action	Page
No operations can be performed with the remote control.	<ul style="list-style-type: none"> • Check the batteries in the remote control. They may need replacing. • Operate the remote control at a distance of no more than 20 feet. • Remove batteries and hold down one or more buttons for several minutes to drain the microprocessor inside the remote control to reset it. Reinstall batteries and try to operate the remote control again. 	P5
Disc does not play.	<ul style="list-style-type: none"> • Ensure that the disc is installed with the label side facing up. • Check the region number of the DVD. 	P8
5.1 channel sound is not being reproduced.	<ul style="list-style-type: none"> • 5.1 channel sound is reproduced only when the following conditions are met. : 1) The DVD player is connected with the proper Amplifier 2) The disc is recorded with 5.1 channel sound. • Check whether the disc being played has the "5.1 ch" mark on the outside. • Check if your audio system is connected and working properly. • In a SETUP Menu, is the Audio Output set to Bitstream? 	P19 P50-51
The  icon appears on screen.	<ul style="list-style-type: none"> • The features or action cannot be completed at this time because: 1. The DVD's software restricts it. 2. The DVD's software doesn't support the feature (e.g., angles). 3. The feature is not available at the moment. 4. You've requested a title or chapter number or search time that is out of range. 	
Disc Menu doesn't appear.	<ul style="list-style-type: none"> • Check if the disc has a Menu. 	
Play mode differs from the Setup Menu selection.	<ul style="list-style-type: none"> • Some of the functions selected in the Setup Menu may not work properly if the disc is not encoded with the corresponding function. 	P43-57
The screen ratio cannot be changed.	<ul style="list-style-type: none"> • The Screen Ratio is fixed on your DVDs. 	P52-53
No audio.	<ul style="list-style-type: none"> • Make sure you have selected the correct Digital Output in the Audio Options Menu. 	P50-51
The screen is blocked	<ul style="list-style-type: none"> • Press the ▶▶ button for more than 5 seconds with no disc inside and the tray closed. All settings will revert to the factory settings. 	P20
Forgot password	<ul style="list-style-type: none"> • Press the ▶▶ button for more than 5 seconds with no disc inside and the tray closed. All settings including the password will revert to the factory settings. Don't use this unless absolutely necessary. 	P55-57
If you experience other problems.	<ul style="list-style-type: none"> • Go to the contents and find the section of the instruction book that contains the explanations regarding the current problem, and follow the procedure once again. • If the problem still cannot be solved, please contact your nearest Samsung authorized service center or call 1-800-SAMSUNG. 	
The picture is noisy or distorted	<ul style="list-style-type: none"> • Make sure that the disc is not dirty or scratched. • Clean the disc. 	P4

REFERENCE

Problem	Action	Page
No HDMI output.	<ul style="list-style-type: none"> • Check the Video output is HDMI enabled. • Check the connection between the TV and the HDMI jack of DVD player. • See if the TV supports this 480p/720p/768p/1080i DVD player. 	P16~17
Abnormal HDMI output screen.	<ul style="list-style-type: none"> • If snow noise appears on the screen, it means that TV does not support HDCP (High-bandwidth Digital Content Protection). 	P16~17
HDMI output Jitter	<ul style="list-style-type: none"> • Check your TV system setup correctly. • The screen Jitter phenomenon may occur when frame rate is converted from 50Hz to 60Hz for 720P/1080i HDMI (High Definition Multimedia Interface) Output. • Please refer to the user's manual of your TV. 	P52~54

REFERENCE

Specifications

General	Power Requirements	AC 120V, 60 Hz
	Power Consumption	12 W
	Weight	5.07 lbs
	Dimensions	16.9 (W) x 8.1 (D) x 1.7 (H) inches
	Operating Temperature Range	+41°F to +95°F
	Operating Humidity Range	10 % to 75 %
Disc	DVD (DIGITAL VERSATILE DISC)	Reading Speed : 3.49 ~ 4.06 m/sec. Approx. Play Time (Single Sided, Single Layer Disc) : 135 min.
	CD : 12Cm (COMPACT DISC)	Reading Speed : 4.8 ~ 5.6 m/sec. Maximum Play Time : 74 min.
	CD : 8Cm (COMPACT DISC)	Reading Speed : 4.8 ~ 5.6 m/sec. Maximum Play Time : 20 min.
	VCD : 12Cm	Reading Speed : 4.8 ~ 5.6 m/sec. Maximum Play Time : 74 min. (Video + Audio)
Video Output	Composite Video	1 channel : 1.0 Vp-p (75 Ω load)
	Component Video	Y : 1.0 Vp-p (75 Ω load)
		Pr : 0.70 Vp-p (75 Ω load) Pb : 0.70 Vp-p (75 Ω load)
	S-Video	Luminance Signal : 1.0 Vp-p (75 Ω load)
HDMI	Chrominance Signal : 0.286 Vp-p (75 Ω load) 480p, 720p, 768p, 1080i	
Audio Output	2 Channel	L(1/L), R(2/R)
	*Frequency Response	48 kHz Sampling : 4 Hz to 22 kHz
		96 kHz Sampling : 4 Hz to 44 kHz
	*S/N Ratio	110 dB
	*Dynamic Range	100 dB
*Total Harmonic Distortion	0.004 %	

*: Nominal specification

- Samsung Electronics Co., Ltd reserves the right to change the specifications with out notice.
- Weight and dimensions are approximate.

Warranty

LIMITED WARRANTY TO ORIGINAL PURCHASER

THIS SAMSUNG BRAND PRODUCT, AS SUPPLIED AND DISTRIBUTED BY SAMSUNG ELECTRONICS AMERICA, INC. (SAMSUNG) AND DELIVERED NEW, IN THE ORIGINAL CARTON TO THE ORIGINAL CONSUMER PURCHASER, IS WARRANTED BY SAMSUNG AGAINST MANUFACTURING DEFECTS IN MATERIALS AND WORKMANSHIP FOR THE FOLLOWING LIMITED WARRANTY PERIOD:

One (1) Year Parts / Ninety (90) days Labor

This limited warranty begins on the original date of purchase, and is valid only on products purchased and used in the United States, and does not include transportation, installation, removal or reinstallation. WARRANTY REPAIRS MUST BE PERFORMED BY SAMSUNG'S AUTHORIZED SERVICE CENTER. TO RECEIVE WARRANTY SERVICE, THE ORIGINAL DATED BILL OF SALE MUST BE PRESENTED UPON REQUEST AS PROOF OF PURCHASE TO SAMSUNG OR SAMSUNG'S AUTHORIZED SERVICE CENTER. TRANSPORTATION TO AND FROM THE SERVICE CENTER IS THE RESPONSIBILITY OF THE PURCHASER.

SAMSUNG WILL REPAIR OR REPLACE THIS PRODUCT, AT OUR OPTION AND AT NO CHARGE WITH NEW OR RECONDITIONED PARTS, IF FOUND TO BE DEFECTIVE DURING THE LIMITED WARRANTY PERIOD SPECIFIED ABOVE. The product must be returned during the warranty period with transportation charges

prepaid to SAMSUNG's designated service center. Prior to returning any product for warranty service, the purchaser must contact SAMSUNG for problem determination and service procedures. SAMSUNG DOES NOT WARRANT UNINTERRUPTED OR ERROR-FREE OPERATION OF THE PRODUCT.

All replaced parts and products become the property of SAMSUNG and must be returned to SAMSUNG. Replacement parts and products assume the remaining original warranty, or ninety (90) days, whichever is longer.

This limited warranty covers manufacturing defects in materials and workmanship encountered in normal, noncommercial use of this product and shall not apply to the following, including, but not limited to: damage which occurs in shipment; applications and uses for which this product was not intended; failures or problems which are caused by products or equipment not supplied by SAMSUNG; accidents, misuse, abuse, neglect, misapplication, fire, water, lightning or other acts of nature; incorrect electrical line voltage, fluctuations or surges; damage caused by improper or faulty installation; improper connection with any peripheral; product alteration or modification; improper or unauthorized repair; cosmetic damage or exterior finish; product with altered serial numbers; failure to follow operating instructions, customer adjustments, maintenance and environmental instructions that are covered and prescribed in the instruction book; use of non-SAMSUNG or unauthorized parts, supplies, accessories or equipment which damage this product or result in service problems; failures or problems due to incompatibility with other equipment.



ELECTRONICS

HEADQUARTERS
105 Challenger Road
Ridgefield Park, NJ 07660-0511
TEL: 1-800-SAMSUNG

SERVICE DIVISION
400 Valley Road, Suite 201
Mount Arlington, NJ 07856
1-800-SAMSUNG (1-800-726-7864)
www.samsung.com